

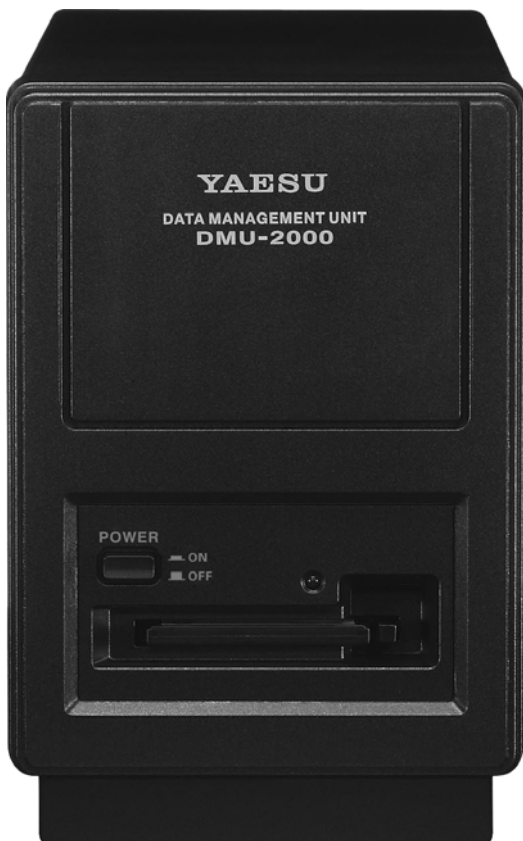

DATA MANAGEMENT UNIT

DMU-2000

OPERATING MANUAL



VERTEX STANDARD CO., LTD.
4-8-8 Nakameguro, Meguro-Ku, Tokyo 153-8644, Japan

VERTEX STANDARD
US Headquarters
10900 Walker Street, Cypress, CA 90630, U.S.A.

YAESU UK LTD.
Unit 12, Sun Valley Business Park, Winnall Close
Winchester, Hampshire, SO23 0LB, U.K.

VERTEX STANDARD HK LTD.
Unit 5, 20/F., Seaview Centre, 139-141 Hoi Bun Road,
Kwun Tong, Kowloon, Hong Kong

VERTEX STANDARD (AUSTRALIA) PTY., LTD.
Normanby Business Park, Unit 14/45 Normanby Road
Notting Hill 3168, Victoria, Australia

TABLE OF CONTENTS

Installation and Connection (FT-2000/D)	1
Installation and Connection (FT-950)	2
Installation and Connection (FTdx5000)	3
Switches and Connectors	4
Please Read This First	6
Before Using an External Monitor	10
About the DMU-2000 Data Management Operation	10
About the Monitor Display	12
How to Use the World Clock function	14
About the World Clock	14
Explanation of the Function Keys on the World Map Screen	14
SET (LOCAL-TIME1) Setup	15
FORMAT (TIME FORMAT) Setup	15
City Selection	16
Miscellaneous World Clock Setup Options	17
OFF Timer and Alarm Setup	18
Spectrum Scope	20
About the Spectrum Scope	20
Explanation of the Function Keys on the Spectrum Scope Screen	20
Using the CTR (Center) Display Mode	22
Using the LBWS (Limited Band Width Sweep) Function	24
Using the FIX (Fixed) Mode	25
Audio Scope and Oscilloscope	26
About the Audio Scope and Oscilloscope	26
Explanation of the Function Keys on the Audio Scope and Oscilloscope Screen	26
Using the Audio Scope	27
Audio Scope Specifications	27
Using the Oscilloscope	28
Oscilloscope Specifications	28
Log Book Function	30
About the Log Book	30
Explanation of the Function Keys on the Log Book Screen	30
Log Book Example	31
CONFIG Setting	32
CONFIG SETTING Mode Setup	33
Log Book Data Input	34
Log Book Previous-QSO Check (CHECK)	35
Editing Log Book Entries	35
Saving Log Data	36
Loading Log Data (LOAD)	36
Summary Check	37
Temperature / SWR Indication	38
About the Temperature / SWR Indication	38
Explanation of the Function Keys on the Temperature / SWR Indication Screen	38
Graphic Meter Displays	39
Swept SWR Display	40
Using the Marker on the SWR Graph	41
Great Circle Map / Rotator Control Function	42
About the Great Circle Map / Rotator Control Function Screen	42
Explanation of the Function Keys on the Great Circle Map / Rotator Control Function Screen	42
Manual Mode	44
Preset Mode	45
Memory Mode	46
Using the Memory Channel List	47
About the Memory Channel List	47
Explanation of the Function Keys on the Memory Channel List Screen	47
Erasing a Memory Channel/Restoring an Erased Memory Channel	48
Saving Memory Data	48
Loading Memory Data	49
Using the MENU Mode	50
Explanation of the Function Keys on the Menu Mode Screen	50
Menu Mode Configuration Changes	51
Menu Mode Reset	51
Saving Menu Configuration Data	52
Loading Menu Data	52

INSTALLATION AND CONNECTION

FT-2000/FT-2000D

1. Make certain that all cables are disconnected from the transceiver.
2. Referring to Figure 1, remove the three screws from each side of the transceiver, and three screws from the top edge of the rear panel. Slide the top cover toward the rear about 1/2 inch (1 cm), then remove the top cover.
3. Refer to Figure 2 for the mounting location for the SCOPE Unit. Locate the 14-pin plug taped on the chassis. Remove the tape and remove the 14-pin plug from the chassis.
4. Mount the SCOPE Unit using the supplied four screws (Figure 3).
5. Referring to Figure 4, plug the 14-pin plug which was removed from the chassis in the previous step into the J7002 connector on the SCOPE Unit.
6. Locate the Coaxial plugs (labeled ⊙ and ⊕) installed in jacks (J4508 and J4507) on the RX-2 Unit. Unplug the Coaxial plug (⊙) from the RX-2 Unit and plug it into J7003 on the SCOPE Unit. Unplug the Coaxial plug (⊕) from the RX-2 Unit and plug it into J7001 on the SCOPE Unit (Figure 4).
7. Replace the top cover and its nine screws.
8. Connect the transceiver, Data Management Unit, after-market Display, and after-market Keyboard (if used) as shown in Figure 5.

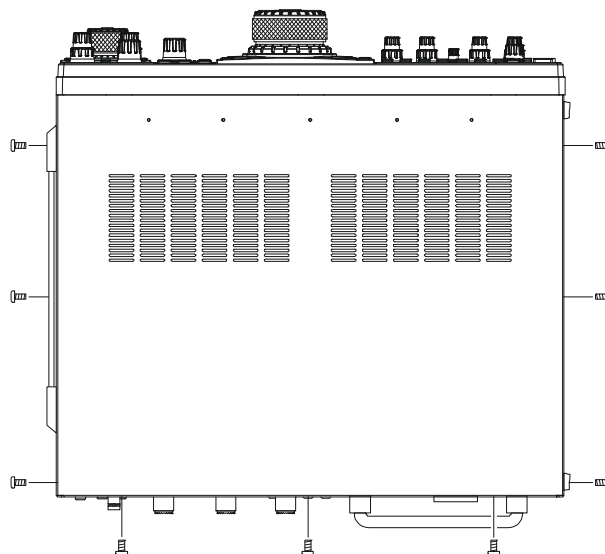

FIGURE 1

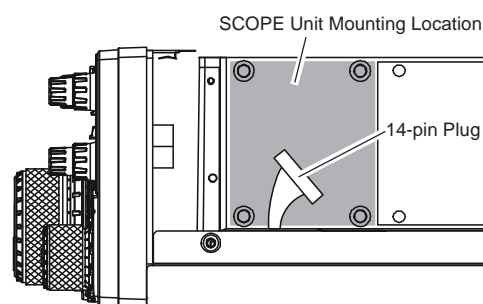

FIGURE 2

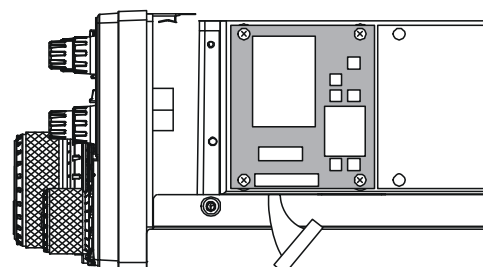

FIGURE 3

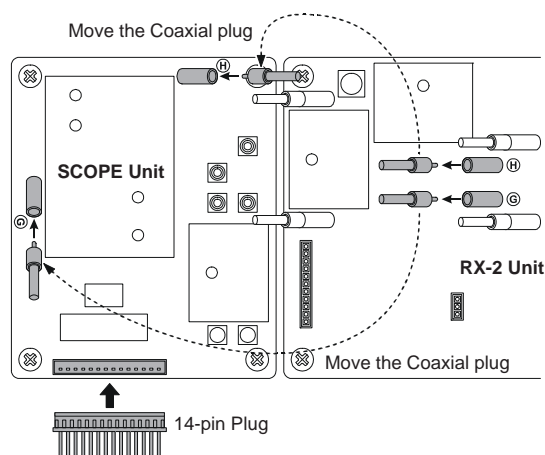

FIGURE 4

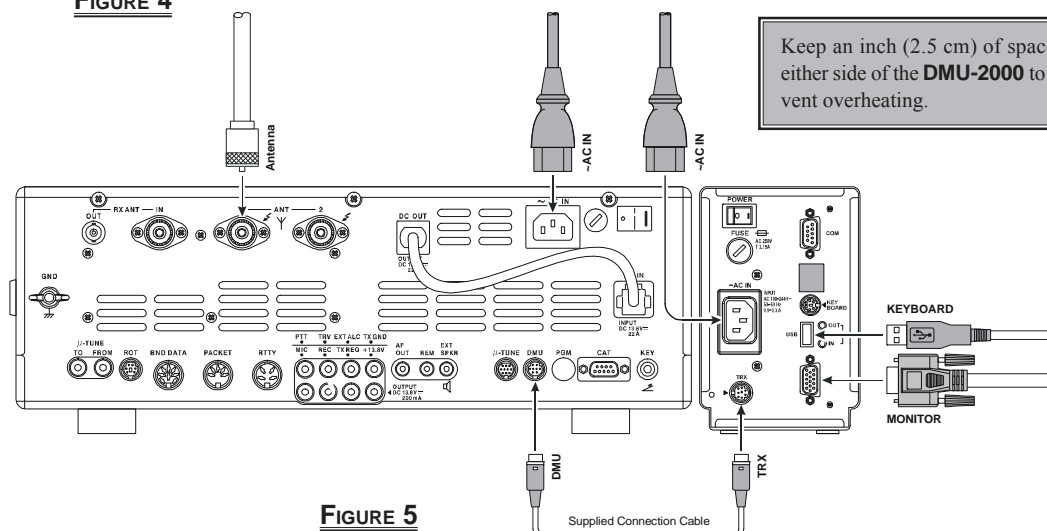

FIGURE 5

INSTALLATION AND CONNECTION

FT-950

1. Make certain that all cables are disconnected from the transceiver.
2. Referring to Figure 1, remove the 18 screws that attach the bottom case, then remove the bottom case.
3. Refer to Figure 2 for the mounting location of the SCOPE Unit. There is a disconnected 14-pin plug.
4. Mount the SCOPE Unit using the supplied four screws (Figure 3).
5. Referring to Figure 3, plug the 14-pin plug which was removed from the chassis in the previous step into connector J7002 on the SCOPE Unit.
6. Locate the Coaxial plug (labeled ⊙) installed in jack (J4006) on the LOCAL Unit. Unplug the Coaxial plug (⊙) from the LOCAL Unit and plug it into J7003 on the SCOPE Unit. Similarly, locate the Coaxial plug (labeled ⊕) installed in jack (J1029) on the MAIN Unit. Unplug the Coaxial plug (⊕) from the MAIN Unit and plug it into J7003 on the SCOPE Unit.
7. Referring to Figure 4, place the Coaxial cables into the slots of the chassis.
8. Replace the bottom case and its 18 screws.
9. Assemble the transceiver, Data Management Unit, after-market Display, and after-market Keyboard (if used) pursuant to Figure 5.

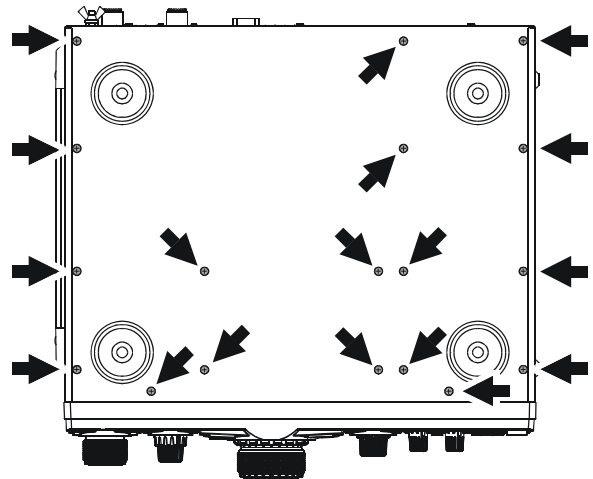

FIGURE 1

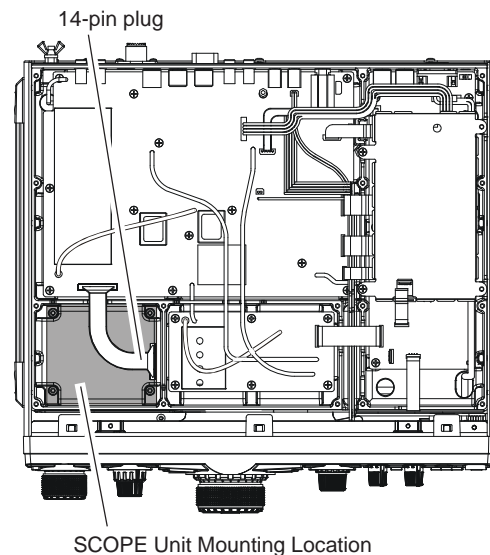

FIGURE 2

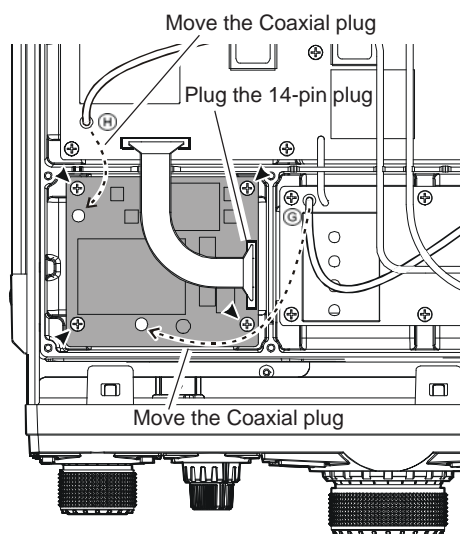

FIGURE 3

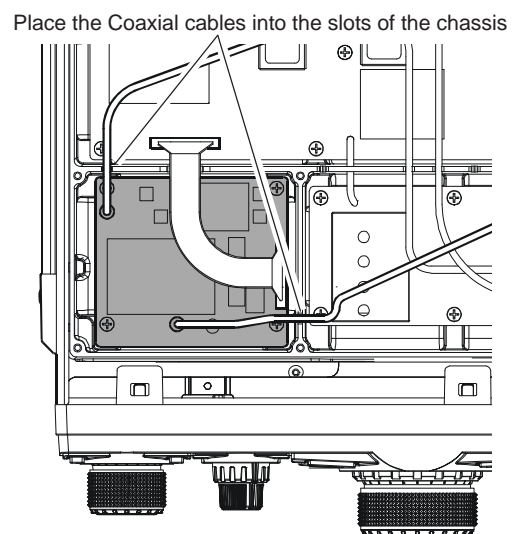

FIGURE 4

INSTALLATION AND CONNECTION

FT-950

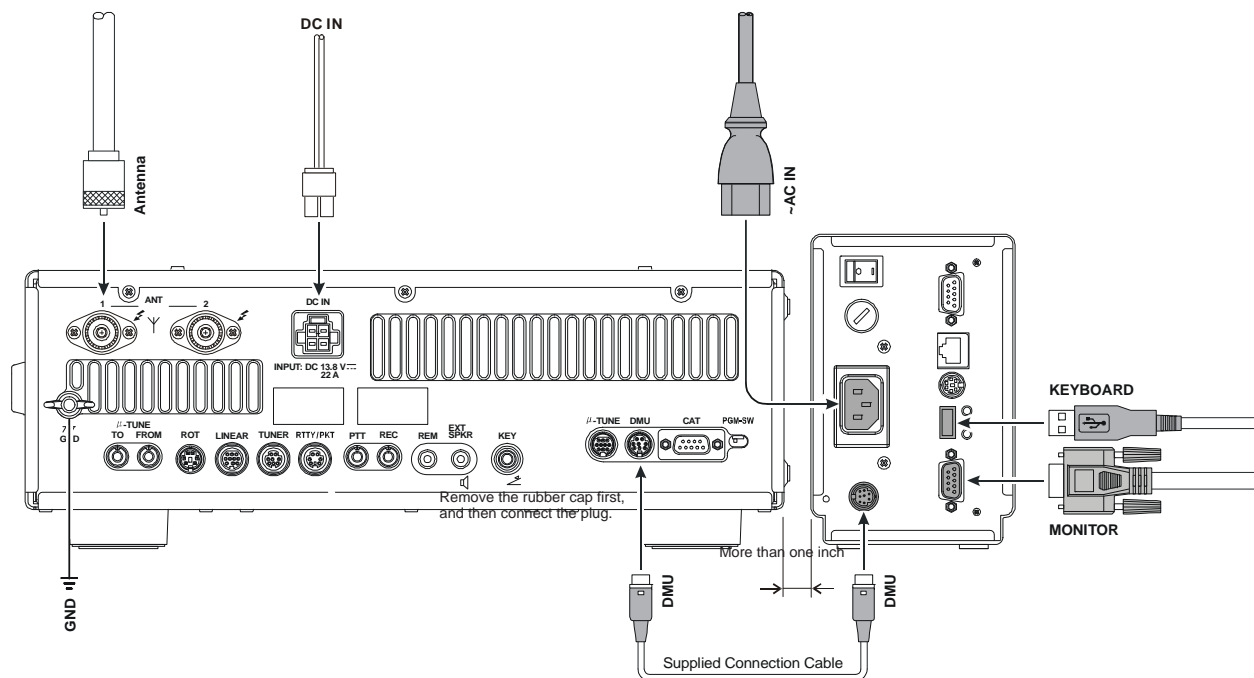
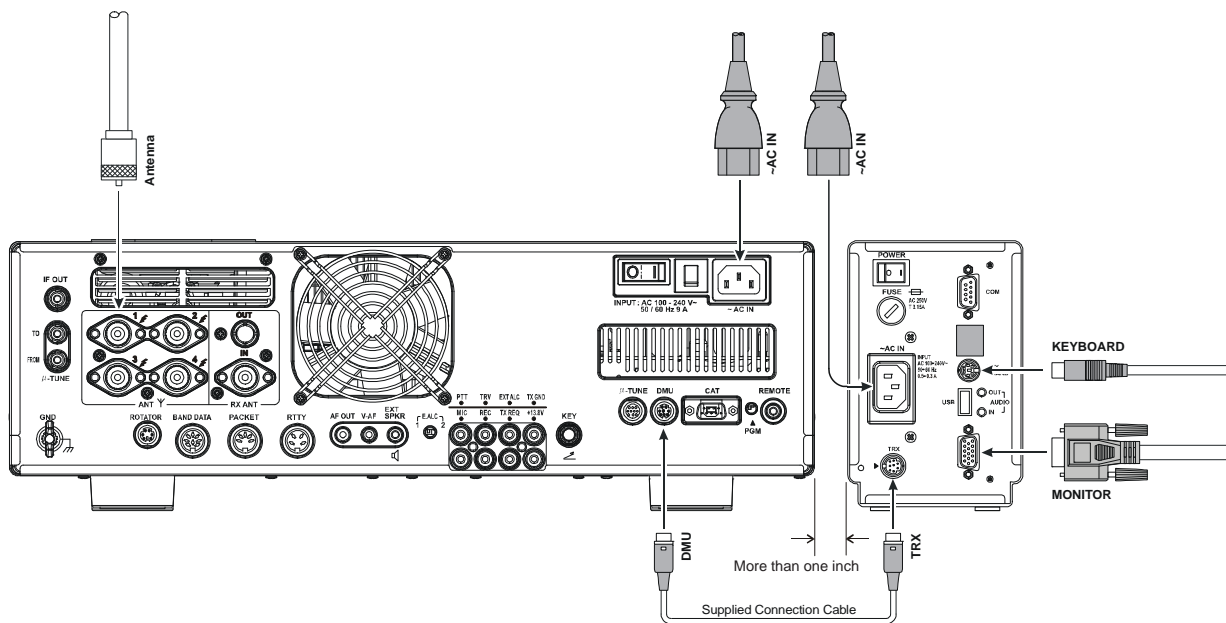

FIGURE 5

FTDx5000

The **FTDx5000** does not need any modifications. Connect the transceiver, Data Management Unit, after-market Display, and after-market Keyboard (if used) as shown in the following illustration.



SWITCHES AND CONNECTORS

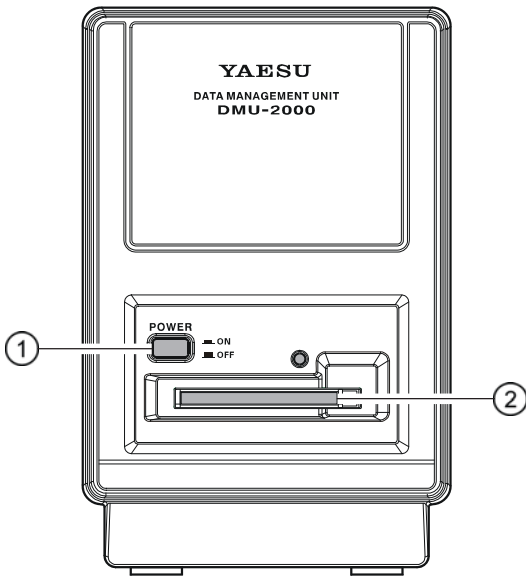

① POWER Switch

Press this switch to turn the Data Management Unit on. Press this switch again to turn the Data Management Unit off. If the rear panel **POWER** switch is set to the “O” position, the front panel **POWER** switch will not function.

② CF Card Slot

This slot accepts the supplied Compact Flash (CF) Card, which allows storage, transfer, and recall of transceiver configuration data and operator preferences, along with Log Book data, etc. When the CF Card is correctly inserted, the red LED by the CF Card slot will light up.

When you insert the CF card into the card slot, please insure that the white side (ridge side) of the CF card is up. If the CF card is inserted incorrectly, the **DMU-2000** may be damaged.

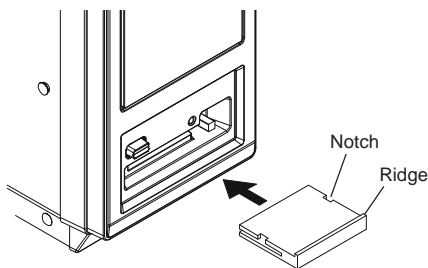

To remove the card out from slot, press the small push-button at the right hand side of the slot.

Advice: If you get the “**CF CARD IS NOT READY**” error message on the after-market monitor, check the position of the CF Card in the slot for proper alignment.

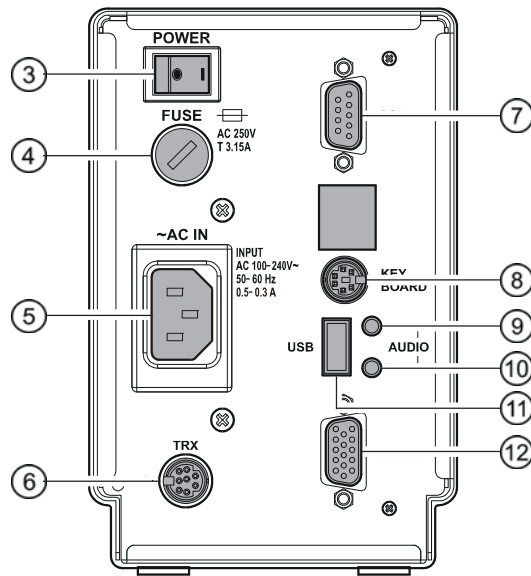

③ Main POWER Switch

This is the main power On (I)/Off (O) switch of the Data Management Unit. Always turn this switch on before turning on the front panel [**POWER**] button. If the rear switch is not turned On, the front panel [**POWER**] switch will not function.

④ FUSE

This holder requires a T 3.15-A fuse. Always use the T 3.15 Amp fuse, whether operating on 100 - 120 VAC or 200 - 240 VAC.

⑤ ~AC IN Jack

Connect the supplied 3-wire AC line cord to this socket after ensuring that your AC mains voltage matches that on the label. See the Installation section for instructions on how to change the internal switching power supply AC mains voltage, if necessary.

⑥ TRX Jack

Connect this 8-pin MINI-DIN jack to the **DMU** jack on the transceiver rear panel, using the supplied control cable.

⑦ COM Jack

Connect a after-market GPS receiver capable of supplying NMEA data to this jack. The data line connects to Pin 2, and the ground shield connects to Pin 5.

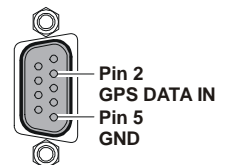

When you connect the GPS receiver to this jack, the “Rotator” page on the after-market monitor will automatically include a Great Circle map centered on your location. The **DMU-2000** can support the RMC Data Sentences from the GPS receiver.

SWITCHES AND CONNECTORS

⑧ KEY BOARD Jack

Connect your keyboard (not supplied) to one of these jacks in accordance with your keyboard type (“USB” or “PS/2”). Use the keyboard to input logbook data, and to input your location when setting up the World Clock.

⑨ AUDIO OUT Jack

This jack is for future expansion of the Data Management Unit’s capabilities, but at this time it is not supported.

⑩ AUDIO IN Jack

This jack is audio signal input for the Audio Scope display of the **DMU-2000**.

You can observe the audio wave of a signal provided by external equipment connected to this jack.

⑪ USB Jack

This jack supports the USB 1.1 protocol, for connection of a USB keyboard.

Note: Other types of USB-related accessories (other than a keyboard) are not supported by this jack, and must not be connected here.

⑫ DISPLAY Jack

Connect an external monitor (not supplied) to this jack.

When you store the data onto the CF card, please use the CF card that is included with the **DMU-2000** package. If you want to use a CF card other than the one supplied by YEASU, you may need to format the card on a Windows PC by using the FAT16 or FAT32 option.

SPECIFICATIONS

Supply Voltage:	100 VAC ~ 240 VAC, 50 ~ 60 Hz (Universal)
Power Consumption (Approx.):	50 VA
Dimensions (WxHxD):	3.9” x 5.3” x 13.8” (100 x 135 x 350 mm)
Weight (Approx.):	5.9 lbs (2.7 kg)

PACKAGING LIST

DMU-2000	1 pc	Connection Cable	1 pc	T9101560	
SCOPE Unit	1 pc	Spare Fuse	1 pc	Q00000096 (3.15A)	
CF Card	1 pc	Q9000855 (128 MB)	Screws	4 pcs	U03306002 (ASM3X6NI)
AC Power Cord	1 pc	T9017882: USA	Operation Manual	1 pc	
		T9013285: Europe	Warranty Card	1 pc	
		T9013283A: Australia			

PLEASE READ THIS FIRST

When turning on the transceiver for the first time, please set the local time as soon as possible. If this is not done, the various functions of the World Clock and Great Circle Map will not operate correctly.

Note: If you wish to add a city to the City List that was programmed at the factory, you will need to supply your own USB or PS/2 Keyboard. If you utilize one of the pre-loaded cities, a keyboard is not necessary.

You may also set up the local time for other locations, without a keyboard, using the cities that have been pre-loaded at the factory.

Please note, there are four power switches that must be turned on for the **DMU-2000** to operate. They are (1) rear main power switch of the transceiver, (2) front actual power switch of the transceiver, (3) rear main power switch of the Data Management Unit, and (4) front panel power switch of the Data Management Unit. The Data Management Unit must be turned on before pressing the power switch on the front panel of the transceiver.

1. TURNING THE TRANSCEIVER ON

❑ FT-2000 (100 W version)

Press the main **[POWER]** switch on the right side of the rear panel, so that the “I” side of the switch is pressed downward, then press the front panel **[POWER]** switch in for two seconds to turn the transceiver on.

❑ FT-2000D (200 W version)

Press the main **[POWER]** switch on the front panel of the **FP-2000**, so that the “I” side of the switch is pressed downward, then press the front panel **[POWER]** switch in for two seconds to turn the transceiver on.

❑ FT-950

Turn on the external DC power supply, and then press the front panel **[POWER]** switch in for two seconds to turn the transceiver on.

❑ FT_{Dx}5000

Press the main **[POWER]** switch on the right side of the rear panel, so that the “I” side of the switch is pressed downward, then press the front panel **[POWER]** switch in for two seconds to turn the transceiver on.

2. TURNING THE DMU-2000 ON

❑ To turn the Data Management Unit on, first press the main **[POWER]** switch (so that the “I” side is pressed downward) on the rear panel, then press the front panel **[POWER]** switch to turn the Data Management Unit on.

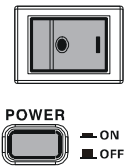

Note: The opening screen will appear on the after-market monitor and the self-check function of the Data Management Unit CPU will begin. When the Data Management Unit is turned on for the first time, it takes about 50 seconds (for self-checking) until the Data Management Unit becomes ready to use; however, the next time you turn it on, it will take around 10 seconds until the Data Management Unit is ready for full operation.

Note

In the discussion to follow, reference will be made to various “Function” keys (for example, **[KEY1(MAP)]**). This nomenclature refers to the **[F1(CH-1)]** ~ **[DISPLAY]** keys located along the bottom left edge of the front panel of the **FT-2000/D** or **[1.8(1)]** ~ **[24.5(8)]** keys of the **FT-950/FT_{Dx}5000** band key. The exact function of each key will depend upon the “Page” of the display being viewed on the monitor; therefore, when using the World Map page, **[KEY1(MAP)]** represents the pressing of the **FT-2000/D**'s **[F1(CH-1)]** key (or the **[1.8(1)]** key of the **FT-950/FT_{Dx}5000**), with “MAP” being the function appearing in the “KEY1” position at the bottom edge of the monitor screen.

MANUAL REFERENCE	FT-950 FT _{Dx} 5000	FT-2000 FT-2000D
[KEY1(xxx)]	[1.8(1)]	[F1(CH-1)]
[KEY2(xxx)]	[3.5(2)]	[F2(CH-2)]
[KEY3(xxx)]	[7(3)]	[F3(CH-3)]
[KEY4(xxx)]	[10(4)]	[F4(CH-4)]
[KEY5(xxx)]	[14(5)]	[F5(MEM)]
[KEY6(xxx)]	[18(6)]	[F6(DEC)]
[KEY7(xxx)]	[21(7)]	[F7(P.BACK)]
[KEY8(xxx)]	[24.5(8)]	[DISPLAY]

3. LOCAL TIME SETUP

- Press and hold in the FT-2000's [DISPLAY] key (or the [ENT] key of the FT-950 or FTdx5000) for more than two seconds, white letters will appear in the tabs at the bottom of the screen to indicate various functions, and the FT-2000's [F1(CH-1)] ~ [F7(P.BACK)] & [DISPLAY] keys (or the [1.8(1)] ~ [24.5(8)] keys of the FT-950 or FTdx5000) will act as "Function" keys.
- A World Map should be displayed on the monitor. If the World Map does not appear, press the [KEY1(MAP)] key to get the World Map to display on the monitor.

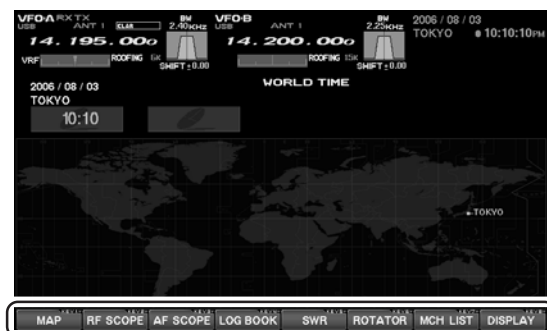

FUNCTION TABS

- Press the [KEY8(DISPLAY)] key to change the action of the "Function" keys, then press the [KEY1(SET)] key; the monitor should now show "LOCAL TIME-1," this setting has been pre-set for Japanese time at the factory.



4. CHANGING THE LOCATION

(1) Using the World Map

- Choose (highlight) the "ZONE" using the [KEY1(▼)] ~ [KEY4(▶)] keys, then press the [KEY7(SELECT)] key.
- The name of the country associated with the highlighted Time Zone may now be selected using the [KEY1(▼)] ~ [KEY4(▶)] keys. Press the [KEY7(SELECT)] key when you have made your selection.
- You may now select one of the displayed cities in the same way. When you have made your choice, press the [KEY7(SELECT)] key.

Advice: Depending on the country, there may be only one city (or no cities) listed. In these instances, to modify the setting, please first select a city name on the list, even if you do not see the city you want; you may modify the city name later.

(2) Using the Longitude/Latitude Data

If you know the Longitude/Latitude of your location, you may set the location from the Longitude/Latitude data.

- Press the [KEY6(LON/LAT)] key. The display changes as follows.



- Press the [KEY7(SELECT)] key, then enter the Longitude using the [KEY1(▼)] ~ [KEY4(▶)] keys. Use the [KEY3(◀)] and [KEY4(▶)] keys to navigate to each column, then use the [KEY1(▼)] and [KEY2(▲)] keys to select the desired numbers in each column.

Note: The Longitude data is input in decimal form. The seconds may also be input in sexagenary form. For example, if you want to input 138 degree 28 minutes 15 seconds,

 1. Input "13828.00" by using [KEY1(▼)] ~ [KEY4(▶)] keys.
 2. Press [KEY4(▶)] key and move the cursor to the right side of the column.
 3. Input "15."
 4. Press [KEY7(SELECT)] key, and the numeric (second) will be converted to the decimal number and the Longitude input is completed.
- When entry is complete, press the [KEY7(SELECT)] key again.
- Choose (highlight) "LAT" using the [KEY1(▼)] ~ [KEY4(▶)] keys, then press the [KEY7(SELECT)] key.
- Enter the Latitude in the same manner as described above.
- When entry is complete, press the [KEY7(SELECT)] key again.

PLEASE READ THIS FIRST

(3) Using the GPS Receiver

If you connect the GPS receiver (not supplied) to the COM jack on the rear panel, your location (Longitude/Latitude) is set automatically.

- Press the [KEY6(LON/LAT)] key. The display will indicate the Longitude/Latitude of your location.
- Press the [KEY6(GPS)] key to re-read the GPS data.



5. CHANGING THE CITY NAME

(To manually enter a city name, connect a PS/2 or USB Keyboard (not supplied). If you do not wish to enter a new city name, please skip to step (6) below).

- Use the [KEY1(▼)] and [KEY2(▲)] keys to highlight the “CITY,” then press the [KEY7(SELECT)] key. Enter the name of the desired city from your keyboard.



- When you have completed your input, press the [KEY7(SELECT)] key once more.

IMPORTANT NOTE

When a full reset is performed on the transceiver, the DMU-2000's data will also be reset, if the DMU-2000's [POWER] switch is also on.

6. CORRECTING THE DATE

- Use the [KEY1(▼)] and [KEY2(▲)] keys to highlight “DATE,” then press the [KEY7(SELECT)] key.
- Use the [KEY3(◀)] and [KEY4(▶)] keys to navigate to each column of the date, then use the [KEY1(▼)] and [KEY2(▲)] keys to select the desired numbers in each column. Repeat for each column, to complete the date.



- When entry is complete, press the [KEY7(SELECT)] key.

7. TIME SETTING

- Press the [KEY1(▼)] or [KEY2(▲)] key to highlight “TIME,” then press the [KEY7(SELECT)] key to enter the time entry mode.
- Use the [KEY3(◀)] and [KEY4(▶)] keys to navigate to the desired column in the date, then use the [KEY1(▼)] and [KEY2(▲)] keys to select the desired number in each column. Time is entered in 24-hour format.



- When entry is complete, press the [KEY7(SELECT)] key.

MANUAL REFERENCE	FT-950 FTdx5000	FT-2000 FT-2000D
[KEY1(XXX)]	[1.8(1)]	[F1(CH-1)]
[KEY2(XXX)]	[3.5(2)]	[F2(CH-2)]
[KEY3(XXX)]	[7(3)]	[F3(CH-3)]
[KEY4(XXX)]	[10(4)]	[F4(CH-4)]
[KEY5(XXX)]	[14(5)]	[F5(MEM)]
[KEY6(XXX)]	[18(6)]	[F6(DEC)]
[KEY7(XXX)]	[21(7)]	[F7(P.BACK)]
[KEY8(XXX)]	[24.5(8)]	[DISPLAY]

8. SETTING UP DAYLIGHT SAVING TIME

- Once you have selected the city to be utilized, use the [KEY1(▼)] and [KEY2(▲)] keys to highlight “DST” (DAYLIGHT SAVING TIME).
- Use the [KEY3(◀)] and [KEY4(▶)] keys to choose “ON” or “OFF.”

9. SAVING AND CLOSING

- When you are satisfied with all of the above entries, press and hold in the [KEY7(SELECT)] key for two seconds to save all the new settings. The chosen city and time zone will appear on the World Map page.

Note: The [KEY1(SET)] key is only used when setting the city name and local time. If you make a mistake, press the [KEY7(SELECT)] key for 2 seconds to return to the World Map screen.

BEFORE USING AN EXTERNAL MONITOR

ABOUT DMU-2000 DATA MANAGEMENT UNIT OPERATION

A number of informative and useful displays will appear on the after-market monitor, which is connected to the DISPLAY terminal on the **DMU-2000** rear panel. These include the World Clock, Spectrum Scope, Audio Scope and Oscilloscope, Log Book, Temperature and SWR indications, Rotator Control with a Great Circle Map, and Memory Channel List. These various “pages” may be selected by pressing the **[KEY1(MAP)]** ~ **[KEY7(MCH LIST)]** keys. Please see the illustrations below and on the next page for details.

1. Press and hold in the **FT-2000**'s **[DISPLAY]** key (or **FT-950**'s or **FTDx5000**'s **[ENT]** key) for at least two seconds.

White lettered tabs will appear at the bottom of the screen to indicate the various functions, and the **FT-2000**'s **[F1(CH-1)]** ~ **[F7(P.BACK)]** & **[DISPLAY]** keys (or **FT-950**'s or **FTDx5000**'s **[1.8(1)]** ~ **[24.5(8)]** keys) will act as the “Function” keys.

If you once more press and hold in the **[DISPLAY]** key (or **FT-950**'s or **FTDx5000**'s **[ENT]** key) for at least two seconds, the white-lettered tabs will disappear, and control of the various functions will be turned cut off, the **FT-2000**'s **[F1(CH-1)]** ~ **[F7(P.BACK)]** & **[DISPLAY]** keys (or **FT-950**'s or **FTDx5000**'s **[1.8(1)]** ~ **[24.5(8)]** keys) will control the transceiver functions and will no longer act as the **DMU-2000** “Function” keys.

2. Press any of the **[KEY1(MAP)]** ~ **[KEY7(MCH LIST)]** keys briefly, to bring up a new display page.

If you do not want to change the setting, or if you wish to suspend the setting procedure, press the **FT-2000**'s **[DISPLAY]** key (or **FT-950**'s or **FTDx5000**'s **[ENT]** key). Any changes you started will not be saved, and the screen will move forward to the next display.

The action of the function keys may vary on each screen. The functions are indicated at the bottom of the screen; please confirm the function displayed as you read along.

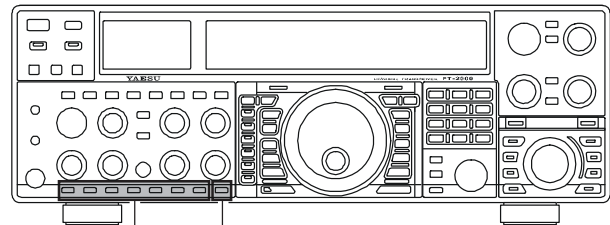

[DISPLAY] Key
Function Keys

FT-2000/D

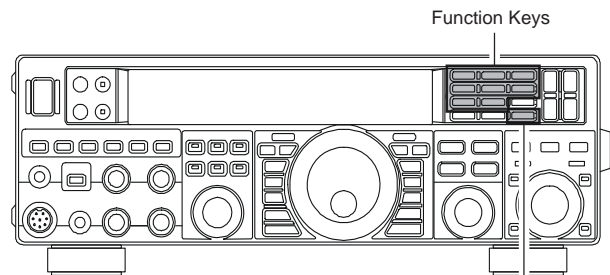

Function Keys

[ENT] Key

FT-950

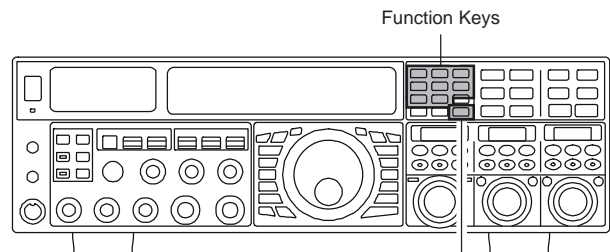

Function Keys

[ENT] Key

FTDx5000

The screenshot shows a world clock display with a map of the world. At the top, it displays '2006 / 08 / 03 TOKYO' and '10:10:10PM'. Below the map, there are several function tabs: MAP, RF SCOPE, AF SCOPE, LOG BOOK, SWR, ROTATOR, MCH LIST, and DISPLAY. Below these tabs are three rows of function keys: the first row has keys labeled F1 CH-1 through F7 P.BACK and DISPLAY; the second row has keys labeled 1.8 1 through 24.5 8; and the third row has keys labeled 1.8 1 through 24.5 8.

FUNCTION TABS

FT-2000/D KEYS

FT-950 KEYS

FTDx5000 KEYS

BEFORE USING AN EXTERNAL MONITOR

ABOUT DMU-2000 DATA MANAGEMENT UNIT OPERATION

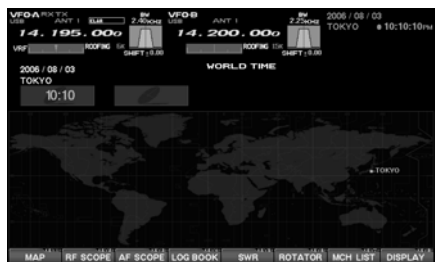

Press and hold in the [DISPLAY] key (FT-2000) or [ENT] key (FT-950 and FTx5000)



The white-lettered tabs disappear

Press the [KEY1(MAP)] key

Press the [KEY2(RF SCOPE)] key

Press the [KEY3(AF SCOPE)] key

Press the [KEY4(LOG BOOK)] key

Press the [KEY5(SWR)] key

Press the [KEY6(ROTATOR)] key

Press the [KEY7(MCH LIST)] key

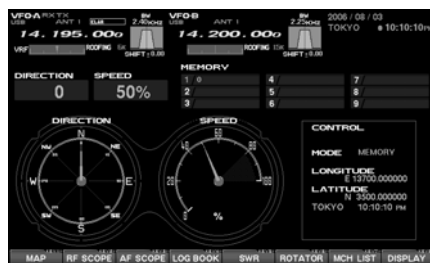

"ROTATOR CONTROL" Screen



"MEMORY CHANNEL LIST" Screen

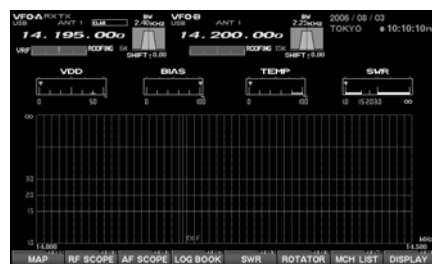

"SWR MONITOR" Screen

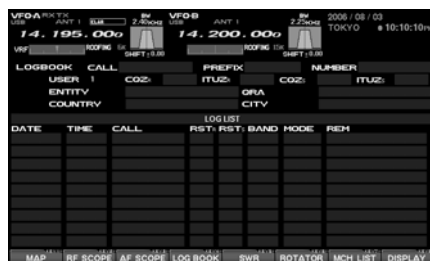

"Log Book" Screen

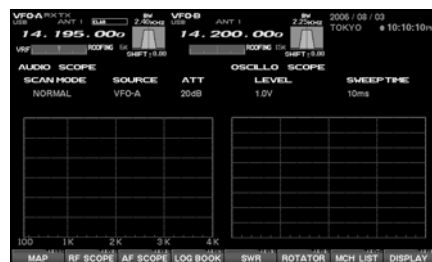

"AUDIO SCOPE / OSCILLO SCOPE" Screen

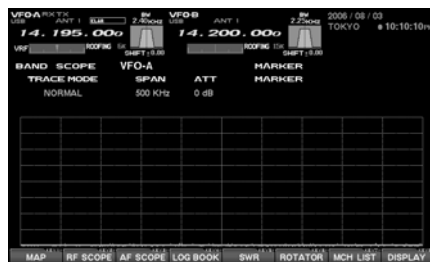

"SPECTRUM SCOPE" Screen



"World Clock" Screen

BEFORE USING AN EXTERNAL MONITOR

ABOUT THE MONITOR DISPLAY

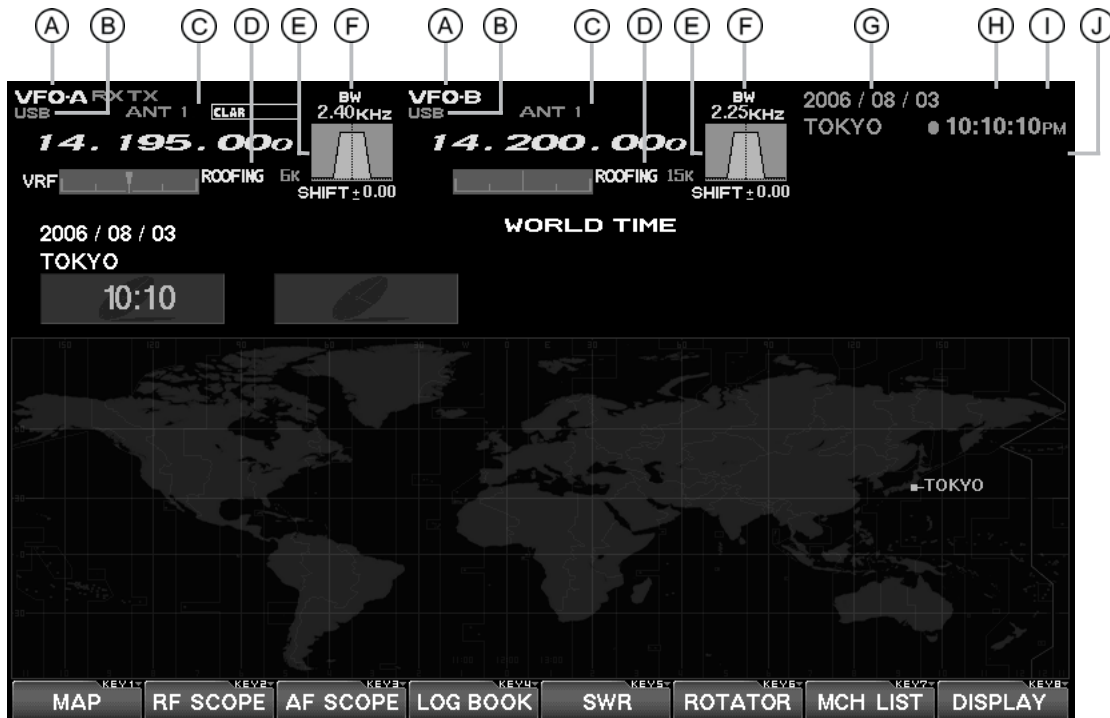

Ⓐ Main (VFO-A) & Sub (VFO-B) Fields

These areas of the Display contain information about the status of the Main (VFO-A) and Sub (VFO-B) VFOs.

Ⓑ MODE Fields

These fields indicate the operating mode in use on the above VFOs.

Ⓒ TX Frequency/Clarifier/ Antenna Selection Fields

These notations advise which VFO is being used for transmission, the status of the Clarifier, and a notation of which antenna has been selected on that VFO.

Ⓓ Filter Fields

These fields note the offset status for the μ -Tuning or VRF filters, as well as the Roofing filter selection, for each VFO.

Ⓔ Filter Shift Fields

These fields graphically depict the positions of the “IF Shift” DSP and RX filter for the Main and Sub VFO.

Ⓕ Bandwidth Fields

This field indicates the net receiver bandwidths currently set for the Main (VFO-A) and Sub (VFO-B).

Ⓖ Date Field

The current date is displayed here.

Ⓗ Local Time-1 Field

The current time at your location (Local Time-1) is displayed here.

Ⓘ GPS Field

If you have connected an after-market GPS unit (one providing NMEA location data) to the rear panel of the transceiver, The white “GPS” icon will appear here. When your location is displayed on a World Map with the GPS data, the base color of the “GPS” icon turns yellow.

Ⓙ Local Time-2 Field

The Local Time-2 time, as programmed, will appear here.

BEFORE USING AN EXTERNAL MONITOR

ABOUT THE MONITOR DISPLAY

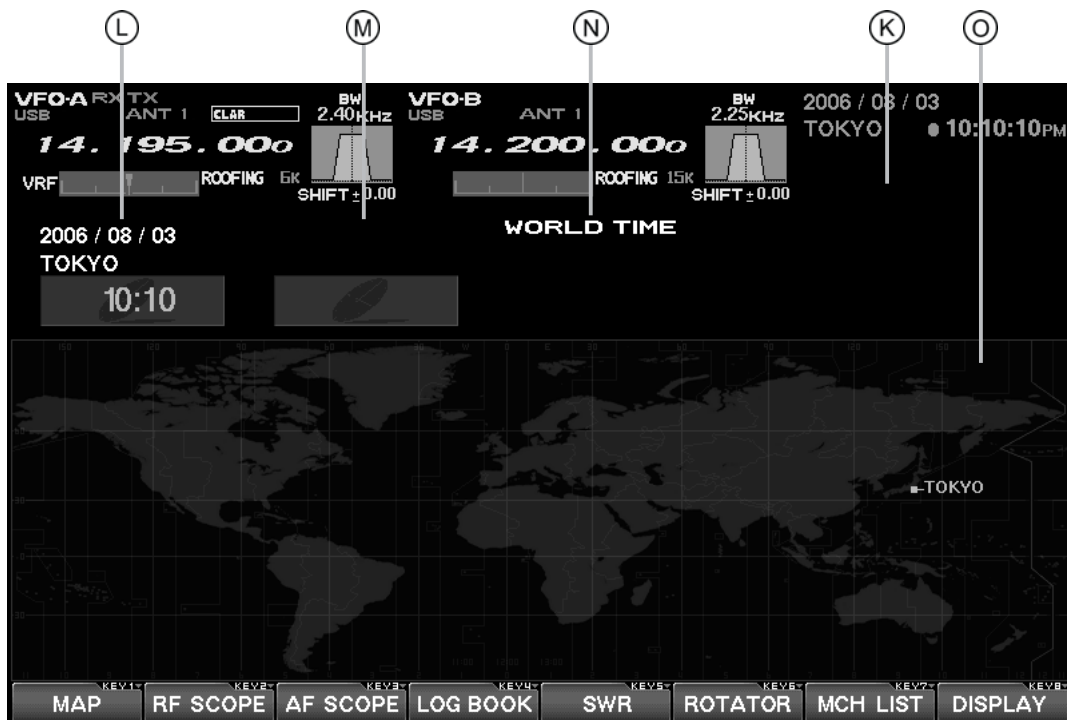

Ⓚ Timer Field

When the On Timer is enabled, “**TIMER**” will appear here; when the Alarm is enabled, “**ALARM**” will appear in this field.

Ⓛ Local Time-1 Field

The current time at your location (Local Time-1) is displayed here.

Ⓜ Local Time-2 Field

The Local Time-2 time, as programmed, will appear here.

Ⓝ World Time Field

This area shows the current time at the city selected on the World Map display.

Ⓞ Display Pages

Individual pages are provided for a wide variety of information and command options. Included are the World Clock page, Spectrum Scope page, Audio Scope and Oscilloscope page, Log Book page, Temperature and SWR indications page, Rotator Control with a Great Circle Map page, Memory Channel List page, and the Menu page.

HOW TO USE THE WORLD CLOCK

ABOUT THE WORLD CLOCK

The World Clock displays the time in various countries. The day/night areas are also indicated on the map, including the Grey Line near the terminator. The difference between the daylight areas in the Southern and Northern Hemispheres is displayed correctly, and is updated in real time. For DX hunting, this can be a very important and convenient tool for specific long distance HF QSOs, for example, you can target the time the other station might have access to, say, the 80-meter band, enabling you to complete a QSO. In addition, an alarm is provided which beeps with respect to a designated area at a designated time, and the auto-off timer can also be matched to any desired area you stipulate.

Note: When you turn on the Data Management Unit for the first time after your purchase, please set the Local Time (the place where you operate this radio), and confirm this setting. If this is not done, the various operations of the World Clock and Great Circle Map will not function correctly. Regarding the setting of the Local Time, See the “PLEASE READ THIS FIRST” information.

If the “World Map” screen does not initially appear, press the [KEY8(DISPLAY)] key to switch the Function key operations to the “Page Select Keys,” then press the [KEY1(MAP)] key briefly momentarily to display the “World Map” screen. Next, press the [KEY8(DISPLAY)] key again to toggle the Function key operation to the “Function Keys.”

EXPLANATION OF THE FUNCTION KEYS ON THE WORLD MAP SCREEN

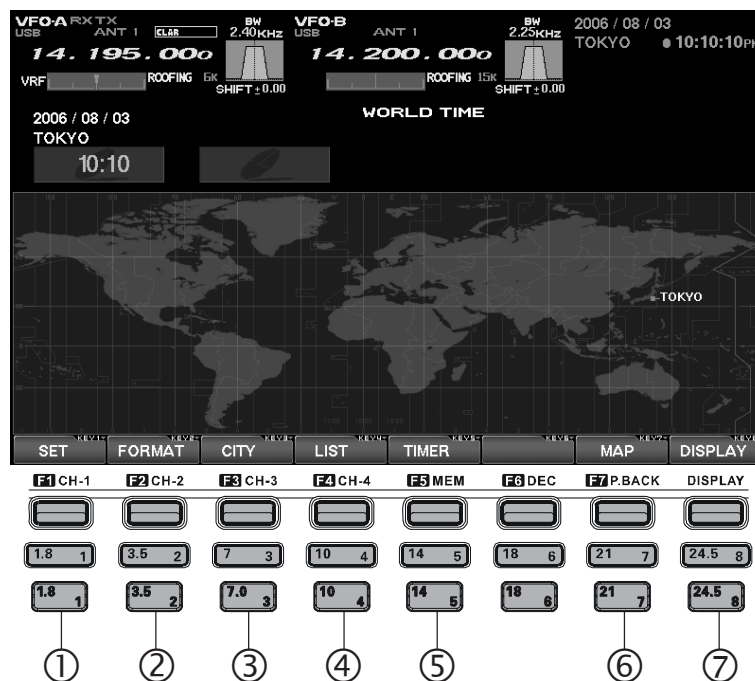

- ① [KEY1(SET)] Key
Selects the LOCAL TIME-1 setup screen.
- ② [KEY2(FORMAT)] Key
Selects 12-hour or 24-hour time format.
- ③ [KEY3(CITY)] Key
Selects the World Map for City selection.
- ④ [KEY4(LIST)] Key
Displays the City setup list.
- ⑤ [KEY5(TIMER)] Key
Selects the TIMER setup screen.
- ⑥ [KEY7(MAP)] Key
This lets you select between the World Map regular screen and the map that includes Daylight/Darkness display.
- ⑦ [KEY8(DISPLAY)] Key
Press this key briefly to toggle the Function key operations between the “Page Select Keys” and the “Function Keys.”
Press and hold in this key to disable the **DMU-2000** Function keys, and return the Key button controls to the **FT-2000/D**, **FT-950**, or **FTdx5000** operations.

HOW TO USE THE WORLD CLOCK

SET (LOCAL-TIME1) SETUP

See the “PLEASE READ THIS FIRST” information (Page 6).

FORMAT (TIME FORMAT) SETUP

This procedure lets you choose between 12-hour and 24-hour time display format.

1. While the World Map is displayed, press the [KEY2(FORMAT)] key to select the “TIME FORMAT” screen.
2. Use the [KEY1(▼)], [KEY2(▲)], [KEY3(◀)], [KEY4(▶)] keys, to select 12-hour or 24-hour display for “LOCAL-TIME1,” “LOCAL-TIME2,” and “WORLD CITY LIST.”

When “SEC” is set to “ON”, the “seconds” digits will be shown in the Local Time indication, at the top right corner of the display.

Advice: If you press the [KEY6(SECADJ)] key, the “seconds” indication will reset to “00.” Use this to sync your clock to a time standard such as WWV.

3. When all settings are complete, press and hold in the [KEY7(SELECT)] key for 2 seconds to exit.

MANUAL REFERENCE	FT-950 FT _{Dx} 5000	FT-2000 FT-2000D
[KEY1(xxx)]	[1.8(1)]	[F1(CH-1)]
[KEY2(xxx)]	[3.5(2)]	[F2(CH-2)]
[KEY3(xxx)]	[7(3)]	[F3(CH-3)]
[KEY4(xxx)]	[10(4)]	[F4(CH-4)]
[KEY5(xxx)]	[14(5)]	[F5(MEM)]
[KEY6(xxx)]	[18(6)]	[F6(DEC)]
[KEY7(xxx)]	[21(7)]	[F7(P.BACK)]
[KEY8(xxx)]	[24.5(8)]	[DISPLAY]



↑
[KEY2(FORMAT)] Key



↑
[KEY6(SECADJ)] Key
Set to “00” Second

HOW TO USE THE WORLD CLOCK

CITY SELECTION

It is possible to enter up to 11 cities in the register. All cities in the register will be displayed on the World Clock screen.

Advice: The order of the display of the cities can be changed later; for now, please just select one of the supplied city names.

There may only be one city shown in some countries; however, it is possible to add cities, if desired.

If you wish to add a city to the City List that was programmed at the factory, you will need to supply your own USB or PS/2 Keyboard. If you utilize one of the pre-loaded cities, a keyboard is not necessary.

1. Press the **[KEY3(CITY)]** key while the World Map is displayed, and the Display will show the "Area Selection" screen.
2. Use the **[KEY1(▼)]**, **[KEY2(▲)]**, **[KEY3(◀)]**, **[KEY4(▶)]** keys to select the continent in which the desired city is located.
3. Confirm that the desired area is highlighted, and press the **[KEY7(SELECT)]** key briefly. Now the country list for the selected continent will be displayed.
4. Use the **[KEY1(▼)]**, **[KEY2(▲)]**, **[KEY3(◀)]**, **[KEY4(▶)]** keys to select the desired country in this area.
5. Now press the **[KEY7(SELECT)]** key briefly, and you will see the list of the city names in the country selected.
6. Use the **[KEY1(▼)]**, **[KEY2(▲)]**, **[KEY3(◀)]**, **[KEY4(▶)]** keys to select the desired city. Even if the city displayed is the only one in the country, select it anyway.
7. When you have completed the above procedure, press the **[KEY7(SELECT)]** key briefly. The selected country name and the city name will be indicated. If you want to input a city name which is not in the list, press the **[KEY7(SELECT)]** key. After confirming that the city name is highlighted, enter the city name you want from your keyboard.
8. Use the **[KEY1(▼)]**, **[KEY2(▲)]**, **[KEY3(◀)]**, **[KEY4(▶)]** keys to set "DAYLIGHT SAVING TIME (Summer Time)," "DISPLAY MAP" (display or not display city names on the World Clock screen), and "HIGHLIGHT" (selects yellow or white highlighted indication for cities).
9. When finished, press and hold in the **[KEY7(SELECT)]** key for 2 seconds to exit.

MANUAL REFERENCE	FT-950 FT-DX5000	FT-2000 FT-2000D
[KEY1(xxx)]	[1.8(1)]	[F1(CH-1)]
[KEY2(xxx)]	[3.5(2)]	[F2(CH-2)]
[KEY3(xxx)]	[7(3)]	[F3(CH-3)]
[KEY4(xxx)]	[10(4)]	[F4(CH-4)]
[KEY5(xxx)]	[14(5)]	[F5(MEM)]
[KEY6(xxx)]	[18(6)]	[F6(DEC)]
[KEY7(xxx)]	[21(7)]	[F7(P.BACK)]
[KEY8(xxx)]	[24.5(8)]	[DISPLAY]



"AREA SELECTION" SCREEN



[KEY7(SELECT)] Key



"COUNTRY SELECTION" SCREEN



[KEY7(SELECT)] Key



"CITY SELECTION" SCREEN

[KEY7(SELECT)] Key

HOW TO USE THE WORLD CLOCK

MISCELLANEOUS WORLD CLOCK SETUP OPTIONS

It is possible to change the order of the selected city times, as well as the display color, etc.

1. On the World Map Screen, press the [KEY4(LIST)] key to select the “City Name List” screen.
2. If you want to change the order of the city times shown across the center of the Display screen, press the [KEY1(▼)] or [KEY2(▲)] keys to move the cursor to the city name you want to reposition of. When the [KEY6(DOWN)] key is pressed, the city is moved down in the list. If you need to move it further, repeat as necessary.
3. If you want to change other settings of a city, select the city name by pressing the [KEY1(▼)] or [KEY2(▲)] keys to highlight the city, then press the [KEY7(SELECT)] key briefly. Now the screen will change to the city setup screen, where the following settings can be made: “DAYLIGHT SAVING TIME” (to select Summer time), “DISPLAY MAP” (display or not display city names on the World Clock screen), and “HIGHLIGHT” (select yellow or white highlighting for the indicated cities).
4. If you want to delete a city from the World Clock screen, move the cursor to the city name by pressing the [KEY1(▼)] or [KEY2(▲)] key, then press the [KEY4(DEL)] key.
5. When finished, press and hold in [KEY7(SELECT)] for 2 seconds to exit.

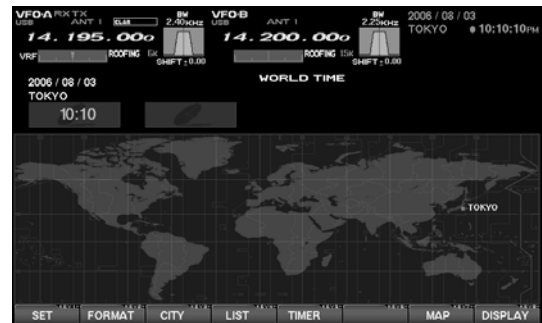

[F4(LIST)] Key

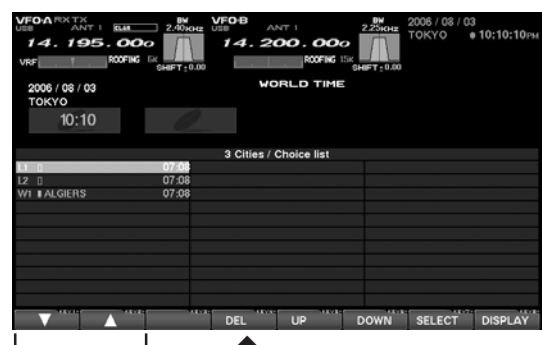

“SELECT” Keys [F4(DELETE)] Key

MANUAL REFERENCE	FT-950 FT _{DX} 5000	FT-2000 FT-2000D
[KEY1(XXX)]	[1.8(1)]	[F1(CH-1)]
[KEY2(XXX)]	[3.5(2)]	[F2(CH-2)]
[KEY3(XXX)]	[7(3)]	[F3(CH-3)]
[KEY4(XXX)]	[10(4)]	[F4(CH-4)]
[KEY5(XXX)]	[14(5)]	[F5(MEM)]
[KEY6(XXX)]	[18(6)]	[F6(DEC)]
[KEY7(XXX)]	[21(7)]	[F7(P.BACK)]
[KEY8(XXX)]	[24.5(8)]	[DISPLAY]

Advice: On the “DISPLAY MAP” setting, if the city name indication is selected, the city name will be displayed on the World Map. When “NO” is selected, the city name will not be displayed on the map, the city name and the current time will only be shown in the center of the Display screen.

For the “HIGHLIGHT” setting (city name: highlighted or not highlighted), if “Highlight” (YES) is selected, the city name on the world map will be shown in yellow font color. If “NOT Highlighted” (NO) is selected, the city name will be indicated in white.

HOW TO USE THE WORLD CLOCK

OFF TIMER AND ALARM SETUP

It is easy to set the OFF Timer and Alarm times.

The OFF TIMER countdown intervals of 120/90/60/30/15 minutes, and OFF, can be selected.

For the ALARM setting: choose either LOCAL-TIME1 or LOCAL-TIME2, set the alarm time, set the Alarm ON or OFF, and/or set CYCLE to sound the alarm one time only or every day.

1. On the World Map screen, press the [KEY5(TIMER)] key to move to the OFF TIMER and ALARM setup screen.
2. Use the [KEY1(▼)], [KEY2(▲)], [KEY3(◀)], [KEY4(▶)] keys to move the cursor to the desired setup item; the selected item will be highlighted.

OFF TIMER setup:

120/90/60/30/15 minutes, and OFF

ALARM setup:

(When setting up the Alarm, be sure to set the OFF TIMER setting to OFF!)

TIME ZONE (LOCAL TIME-1/LOCAL TIME-2)

ALARM TIME

ALARM ON/OFF

CYCLE (ONCE/DAILY)

3. Press and hold in [KEY7(SELECT)] for 2 seconds to close and exit.

MANUAL REFERENCE	FT-950 FT-DX5000	FT-2000 FT-2000D
[KEY1(XXX)]	[1.8(1)]	[F1(CH-1)]
[KEY2(XXX)]	[3.5(2)]	[F2(CH-2)]
[KEY3(XXX)]	[7(3)]	[F3(CH-3)]
[KEY4(XXX)]	[10(4)]	[F4(CH-4)]
[KEY5(XXX)]	[14(5)]	[F5(MEM)]
[KEY6(XXX)]	[18(6)]	[F6(DEC)]
[KEY7(XXX)]	[21(7)]	[F7(P.BACK)]
[KEY8(XXX)]	[24.5(8)]	[DISPLAY]

Advice: When the OFF timer is engaged (power is shut off), the condition of the radio is the same as if the power switch on the front panel has been turned off. The Main power (circuit breaker) is not turned off.

The Alarm will ring for around 60 seconds. If you want to stop the alarm, press any of the keys located on the front panel.

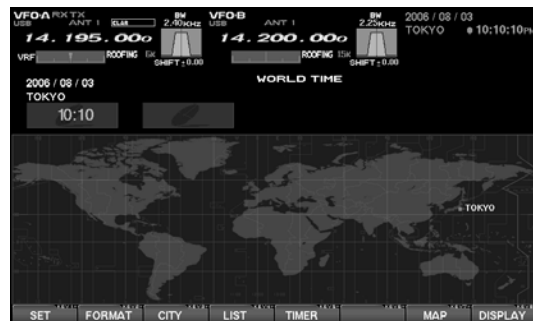

"OFF TIMER AND ALARM SETUP" SCREEN

ABOUT THE SPECTRUM SCOPE

This page displays the Spectrum Scope, which is convenient for monitoring band activity.

The entire screen will become a spectrum display, and Both strong and weak signals from the Main (VFO-A) band receiver are clearly shown.

The LBWS (Limited Band Width Sweep) function provides very high-speed signal detection over a limited band segment.

The CTR mode (your frequency is located at the center of the screen), permits monitoring signals close to your current frequency.

The FIX mode (the left band edge frequency is fixed) can also be engaged. These features have been carefully considered for their utility in actual Amateur Radio operation.

If the “Spectrum Scope” screen does not initially appear, press the [DISPLAY] key to toggle the Function key operations to “Page Select” mode. Then press the [F2(RF SCOPE)] key briefly to display the “Spectrum Scope” screen. Next, press the [DISPLAY] key again to toggle the Function key operations to “Function Keys.”

Quick Point: The vertical axis of the Spectrum Scope is 10 dB per division.

During transmission, the transmitter’s waveform will be displayed.

EXPLANATION OF THE FUNCTION KEYS ON THE SPECTRUM SCOPE SCREEN

The operation of the individual function tabs will change, depending on the display page being viewed. Carefully inspect the function tabs as you change pages, to ensure you are performing the correct and desired function.

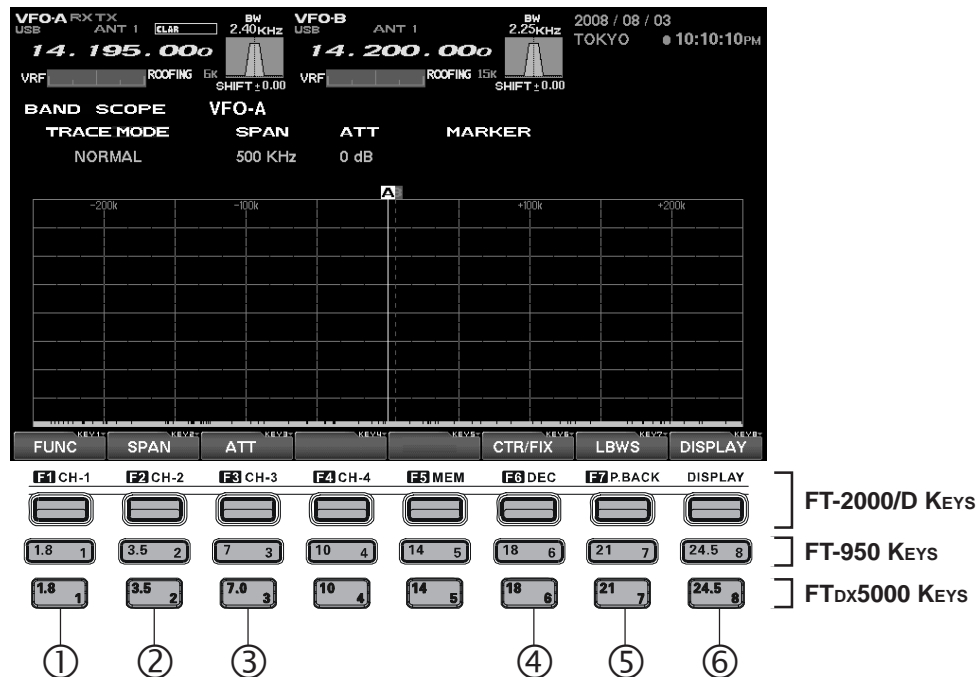

① [KEY1(FUNC)] Key

Moves you to the Spectrum Scope setup screen used for setup of the MKR (Marker) functions, etc.

Advice: On this screen, the functions assigned to the function keys are changed. If you want to return to the previous screen, press the [KEY7(EXIT)] key.

② [KEY2(SPAN)] Key (Bandwidth)

Press this key repeatedly to choose the range of frequencies shown across the spectrum display.

25 kHz → 50 kHz → 100 kHz → 250 kHz →
500 kHz → 1000 kHz → 2500 kHz → 25 kHz ……

If the setting is toggled to 2500 kHz, and you press this key once more, the span returns to 25 kHz again. The current span is indicated below the SPAN indication, above the spectrum display.

EXPLANATION OF THE FUNCTION KEYS ON THE SPECTRUM SCOPE SCREEN

③ [KEY3(ATT)] Key (Attenuator)

Press this key repeatedly to attenuate the displayed signal level as shown below. The noise level on the band will vary according to conditions of your antenna, the time of day, etc.; please select the appropriate value for current conditions.

0 dB → 10 dB → 20 dB → 0 dB

④ [KEY6(CTR/FIX)] Key

Press this key to switch between the CTR mode and FIX mode.

In the CTR mode, the current operating frequency is displayed at the center of the screen. In the FIX mode, the frequency selected via the Menu is fixed at the left edge of the display.

Advice: For ease of status recognition in either CTR or FIX mode, the current operating frequency is indicated on the screen by the Orange colored "A".

⑤ [KEY7(LBWS)] Key

Press this key to activate the "Limited Band Width Sweep" (LBWS) function, which permits high-speed sweeping of a band segment.

As the bandwidth is set narrower, the sweep speed becomes faster, allowing the scope to capture signals with quicker resolution. The bandwidth can be set to 50 %, 30 %, or 10 % of the full span. The sweep speed becomes faster by the following amounts:

50 %: about 2 times faster

30 %: about 3 times faster

10 %: about 10 times faster

NORMAL → LBWS-1 (50%) →

LBWS-2 (30%) → LBWS-3 (10%) → NORMAL

Advice: When you enter the LBWS mode, the operation of the function keys below the Display change.

It is possible to move the position of the LBWS sweep by pressing the [KEY5(◀)] or the [KEY6(▶)] key.

If you want to return to the normal sweep operation, press the [KEY7(LBWS)] key as needed.

NOTE: the LBWS can not be used in the FIX mode, it is only available in the CTR mode.

⑥ [KEY8(DISPLAY)] Key

Press this key briefly to switch the Function key operations between the "Page Select Keys" and the "Function Keys."

Press and hold in this key to disable **DMU-2000** control, and return the key button control to the **FT-2000/D**, **FT-950**, or **FTdx5000** operations.

FIX MODE SETUP (LEFT EDGE FREQUENCY)

Press the [MENU] button briefly to enter the Menu mode. Select the menu item that you want to change by rotating the Main Tuning Dial knob (on the **FT-2000/D**, this will be one of the SCOPE MENU items from MENU "107 SCP 1.8 FIX" to MENU "117 SCP 50.0 FIX". On the **FT-950**, this will be one of the SCOPE MENU items from MENU "073 SCP 1.8 FIX" to "083 SCP 50.0 FIX"). On the **FTdx5000**, rotate the (VFO-A)[SELECT] knob and select one of the SCOPE MENU items from MENU "131 SCP 1.8 FIX" to MENU "141 SCP 50.0 FIX".

Then change the setting by rotating the [SUB VFO-B] knob on the **FT-2000/D**, or the [CLAR/VFO-B] knob on the **FT-950**, or the (VFO-B)[SELECT] knob on the **FTdx5000**.

When the menu changes are completed, press and hold in the [MENU] button for 2 seconds to save the change.

If you do not want to save the change(s), press the [MENU] button briefly. The radio will go back to its previous condition/situation.

USING THE CTR (CENTER) DISPLAY MODE

It is possible to view strong and weak signals received on the Main Band (VFO-A) on the Spectrum Scope. Also, the LBWS (Limited Band Width Sweep) mode permits a high-speed, high-resolution sweep of a limited band segment.

1. Press the **[KEY6(CTR/FIX)]** key to change to the CTR mode.
2. Repeatedly pressing the **[KEY6(CTR/FIX)]** key will toggle between the CTR mode and the FIX mode. In the CTR mode, the Orange colored “**A**” will appear at the center of the display, indicating your current operating frequency.
3. Repeatedly press the **[KEY2(SPAN)]** key to select the desired frequency span to monitor.

The Span selections are:

25 kHz → 50 kHz → 100 kHz → 250 kHz →
500 kHz → 1000 kHz → 2500 kHz → 25 kHz ……

4. Repeatedly press **[KEY3(ATT)]** key to select the desired attenuation value according to current propagation conditions, your operating frequency and antenna, etc.

0 dB → 10 dB → 20 dB → 0 dB ……

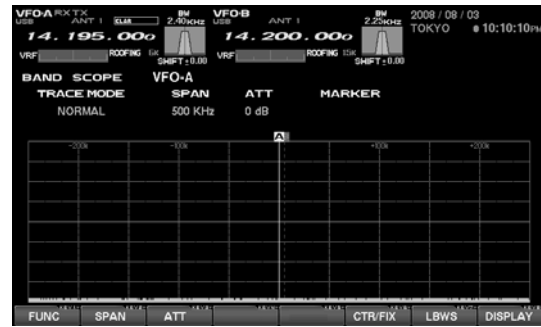

↑ [KEY2(SPAN)] Key ↑ [KEY3(ATT)] Key ↑ [KEY6(CTR/FIX)] Key

MANUAL REFERENCE	FT-950 FT _{Dx} 5000	FT-2000 FT-2000D
[KEY1(XXX)]	[1.8(1)]	[F1(CH-1)]
[KEY2(XXX)]	[3.5(2)]	[F2(CH-2)]
[KEY3(XXX)]	[7(3)]	[F3(CH-3)]
[KEY4(XXX)]	[10(4)]	[F4(CH-4)]
[KEY5(XXX)]	[14(5)]	[F5(MEM)]
[KEY6(XXX)]	[18(6)]	[F6(DEC)]
[KEY7(XXX)]	[21(7)]	[F7(P.BACK)]
[KEY8(XXX)]	[24.5(8)]	[DISPLAY]

USING THE MARKER

- ❑ Press the **[KEY1(FUNC)]** key to show the Marker setup screen. The indication tab **[KEY1(FUNC)]** will change to **[KEY1(MKR ON/OFF)]**; now press the **[KEY1(MKR ON/OFF)]** key once again, and the Marker line will be displayed at the center of the screen.
- ❑ It is possible to change the position of the marker by pressing the **[KEY2(◀)]** or **[KEY3(▶)]** keys. If you want to mark the center of a strong signal, you can move the marker to the screen position occupied by that signal. When the **[KEY5(CF)]** key is pressed briefly (one touch), the marker position will return to the center.
- ❑ In order to remove the marker from the screen, press the **[KEY1(MKR ON/OFF)]** key.

- ❑ When you want to return to the Spectrum Scope screen, press the **[KEY7(EXIT)]** key. If the Marker is displayed, it will remain on the screen.

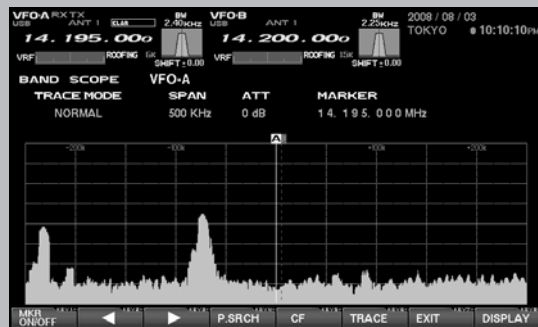

↑ [KEY1(MKR ON/OFF)] Key ↑ [KEY5(CF)] Key

USING THE CTR (CENTER) DISPLAY MODE

Miscellaneous Functions

SEARCHING FOR STRONG SIGNALS

USING THE PEAK SEARCH FEATURE

1. Press the [KEY1(FUNC)] key to display the Marker setup screen.
2. Press the [KEY4(P.SRCH)] key to move the marker to the highest peak signal frequency. With each press of the [KEY4(P.SRCH)] key, the Marker will shift to the strongest signal frequency away from the current frequency.

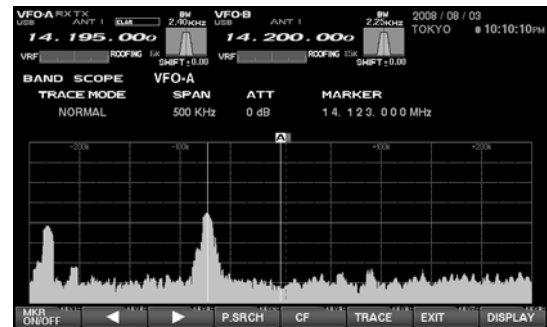

[KEY4(P.SRCH)] Key

CHANGING THE TRACE MODE

1. Press the [KEY1(FUNC)] key to display the Marker setup screen.
2. Repeatedly Press the [KEY6(TRACE)] key to select the Trace mode of the Spectrum Scope.

The Trace mode selections are shown below.

NORMAL → *AVERAGE* →

PEAK HOLD → *NORMAL*

NORMAL: The real-time signal strength will be displayed. Normally, you will want to use this mode.

AVERAGE: The averaged signal strength will be displayed.

PEAK HOLD: The signal level will be displayed, with peak strengths held for a few seconds.

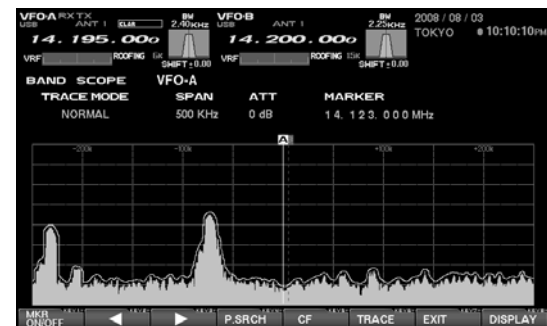

[KEY6(TRACE)] Key

MANUAL REFERENCE	FT-950 FT _{Dx} 5000	FT-2000 FT-2000D
[KEY1(XXX)]	[1.8(1)]	[F1(CH-1)]
[KEY2(XXX)]	[3.5(2)]	[F2(CH-2)]
[KEY3(XXX)]	[7(3)]	[F3(CH-3)]
[KEY4(XXX)]	[10(4)]	[F4(CH-4)]
[KEY5(XXX)]	[14(5)]	[F5(MEM)]
[KEY6(XXX)]	[18(6)]	[F6(DEC)]
[KEY7(XXX)]	[21(7)]	[F7(P.BACK)]
[KEY8(XXX)]	[24.5(8)]	[DISPLAY]

QMB MARKER

If the QMB frequency is within the Spectrum Scope sweep range, the QMB channel's frequency will be displayed on the screen by a white arrow (▽).

You may remove the QMB Marker from the screen via menu item **FT-2000/D: 014 dISP QMB MARKER**, **FT-950: 013 DISP QMB MKR**, or **FT_{Dx}5000: 016 DISP QMB MKR**, if desired.

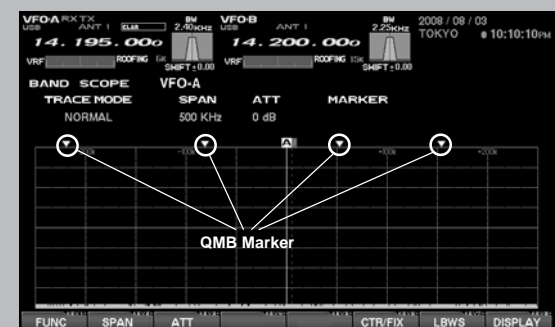

SPECTRUM SCOPE

USING THE LBWS (LIMITED BAND WIDTH SWEEP) FUNCTION

LBWS (Limited Band Width Sweep) is a function that sweeps a limited *segment* of the Spectrum Scope span without *changing* the span (bandwidth). As the sweep segment becomes narrower, the speed becomes faster, and the accuracy and resolution become enhanced.

The bandwidth can be set to 50 %, 30 %, or 10 % of the full span. The sweep speed will increase as follows:

50 %: about 2 times faster, 30 %: about 3 times faster, 10 %: about 10 times faster

1. By pressing the [KEY6(CTR/FIX)] key repeatedly, the CTR mode and the FIX mode will be toggled alternately.
2. Press the [KEY2(SPAN)] key repeatedly, to choose the bandwidth span to be shown on the Spectrum Scope. The bandwidth span choices are:
 $25\text{ kHz} \rightarrow 50\text{ kHz} \rightarrow 100\text{ kHz} \rightarrow 250\text{ kHz} \rightarrow$
 $500\text{ kHz} \rightarrow 1000\text{ kHz} \rightarrow 2500\text{ kHz} \rightarrow 25\text{ kHz} \dots\dots$
3. Press the [KEY3(ATT)] key repeatedly, to choose the desired attenuation value. The attenuation will change as follows:
 $0\text{ dB} \rightarrow 10\text{ dB} \rightarrow 20\text{ dB} \rightarrow 0\text{ dB} \dots\dots$
4. By pressing the [KEY7(LBWS)] key repeatedly, the LBWS (Limited Band Width Sweep) segment width will change as follows.
 $NORMAL \rightarrow LBWS-1 (50\%) \rightarrow$
 $LBWS-2 (30\%) \rightarrow LBWS-3 (10\%) \rightarrow NORMAL \dots\dots$

Advice: The LBWS feature can not be used in the FIX mode. The LBWS is only available in the CTR mode.

MANUAL REFERENCE	FT-950 FT _{Dx} 5000	FT-2000 FT-2000D
[KEY1(xxx)]	[1.8(1)]	[F1(CH-1)]
[KEY2(xxx)]	[3.5(2)]	[F2(CH-2)]
[KEY3(xxx)]	[7(3)]	[F3(CH-3)]
[KEY4(xxx)]	[10(4)]	[F4(CH-4)]
[KEY5(xxx)]	[14(5)]	[F5(MEM)]
[KEY6(xxx)]	[18(6)]	[F6(DEC)]
[KEY7(xxx)]	[21(7)]	[F7(P.BACK)]
[KEY8(xxx)]	[24.5(8)]	[DISPLAY]

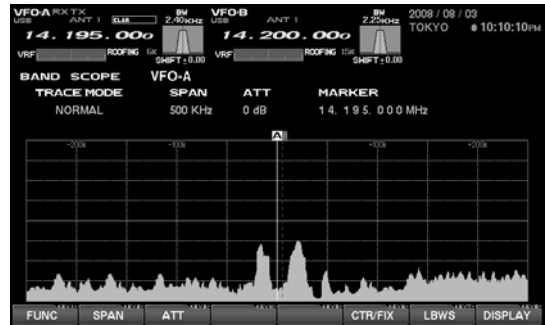

↑ [KEY6(CTR/FIX)] Key

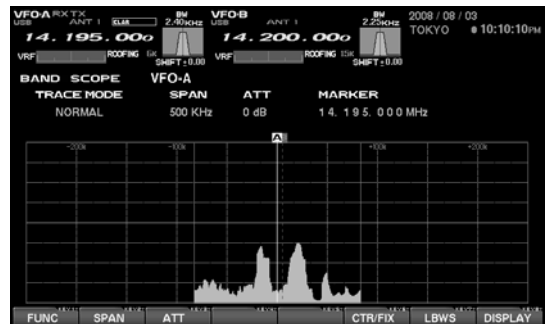

↑ [KEY7(LBWS)] Key

USING THE FIX (FIXED) MODE

This feature is convenient when you want to monitor an entire amateur band.

The starting point, located at the left edge of the screen, can be set via the Menu. Even if the screen span (bandwidth) is changed, the start frequency will *not* be changed. By watching the screen, you can move your operation to frequencies where interesting activity appears on the display.

1. Use the [**KEY6(CTR/FIX)**] key to choose between the CTR mode and the FIX mode.

Select the FIX mode at this time.

2. Press the [**KEY2(SPAN)**] key repeatedly to set the Spectrum Scope Span (bandwidth). The available choices are as follows:

25 kHz → 50 kHz → 100 kHz → 250 kHz →

500 kHz → 1000 kHz → 2500 kHz → 25 kHz

3. Press the [**KEY3(ATT)**] key repeatedly, to set the desired attenuation value. The attenuation will change as follows.

0 dB → 10 dB → 20 dB → 0 dB

4. When you rotate the Main Tuning Dial knob, the Orange colored “[**A**]” will move to follow your receive frequency.

If the receive frequency is outside of the screen, the position of the operating frequency will be “shown” in the lower area of the display as “<<<” “>>>”, and “RCV Freq is out of range” will also be displayed.

5. When **TRCE MODE** is set to “Average” or “Peak” (See page 22), you may reset the screen display by pressing the [**KEY7(REFRESH)**] key.

6. Just as in the CTR mode, you can use the Marker. Please see page 22 for information on using the marker.

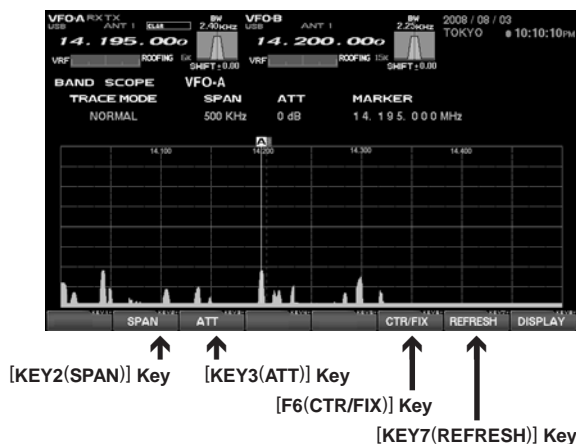

MANUAL REFERENCE	FT-950 FT _{Dx} 5000	FT-2000 FT-2000D
[KEY1(XXX)]	[1.8(1)]	[F1(CH-1)]
[KEY2(XXX)]	[3.5(2)]	[F2(CH-2)]
[KEY3(XXX)]	[7(3)]	[F3(CH-3)]
[KEY4(XXX)]	[10(4)]	[F4(CH-4)]
[KEY5(XXX)]	[14(5)]	[F5(MEM)]
[KEY6(XXX)]	[18(6)]	[F6(DEC)]
[KEY7(XXX)]	[21(7)]	[F7(P.BACK)]
[KEY8(XXX)]	[24.5(8)]	[DISPLAY]

SETTING THE LEFT EDGE FREQUENCY FOR THE FIX MODE

Press the [**MENU**] button briefly to enter the Menu mode. Select the menu item that you want to change by rotating the Main Tuning Dial knob (on the **FT-2000/D**, this will be one of the **SCOPE MENU** items from MENU “107 SCP 1.8 FIX” to MENU “117 SCP 50.0 FIX”. On the **FT-950**, this will be one of the **SCOPE MENU** items from MENU “073 SCP 1.8 FIX” to “083 SCP 50.0 FIX”). On the **FT_{Dx}5000**, rotate the (**VFO-A**)[**SELECT**] knob and select one of the **SCOPE MENU** items from MENU “131 SCP 1.8 FIX” to MENU “141 SCP 50.0 FIX”.

Then change the setting by rotating the [**SUB VFO-B**] knob on the **FT-2000/D**, or the [**CLAR/VFO-B**] knob on the **FT-950**, or the (**VFO-B**)[**SELECT**] knob on the **FT_{Dx}5000**.

When the menu changes are completed, press and hold in the [**MENU**] button for 2 seconds to save the change.

If you do not want to save the change(s), press the [**MENU**] button briefly. The radio will go back to its previous condition/situation.

AUDIO SCOPE AND OSCILLOSCOPE

ABOUT THE AUDIO SCOPE AND OSCILLOSCOPE

The Audio Scope and the Oscilloscope displays are shown on the screen simultaneously.

With the Audio Scope, the horizontal line represents frequency, and you can use this function to view the frequency response within the RX or TX bandwidth. In the Oscilloscope mode, the horizontal line represents time, and you can view the RX signal waveform within the RX bandwidth. The TX waveform is shown during transmissions.

If the “Audio Scope / Oscilloscope” screen does not initially appear, press the [KEY8(DISPLAY)] key to switch the Function key operations to “Page Select Key,” then press the [KEY3(AF SCOPE)] key briefly to display the “Audio Scope / Oscilloscope” screen. Next, press the [KEY8(DISPLAY)] key again to switch the Function key operations to the “Function Keys.”

EXPLANATION OF THE FUNCTION KEYS ON THE AUDIO SCOPE AND OSCILLOSCOPE SCREEN

Here are the uses for the function keys when the Audio scope and Oscilloscope are displayed on the screen.

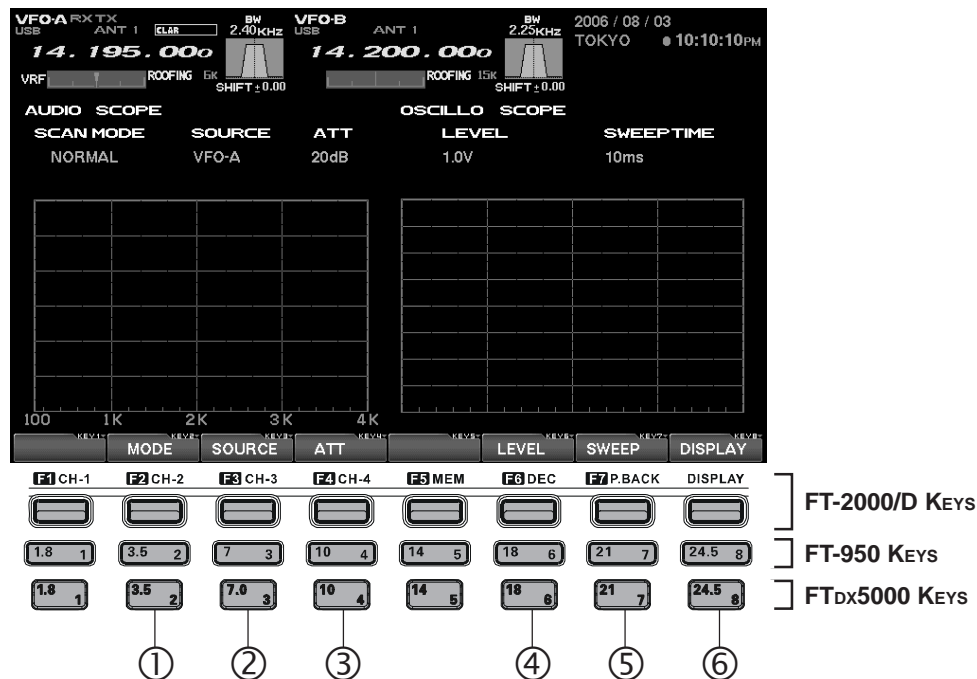

① [KEY2(MODE)] Key

The SCAN MODE for the left-side Audio Scope can be changed. Pressing this key changes The Audio Scope mode as follows:

NORMAL → *WF-1* → *WF-2* → *NORMAL*

“WF-1” and “WF-2” are “Waterfall” displays. The sweep time (speed) of “WF-2” is faster than that of “WF-1.”

② [KEY3(SOURCE)] Key

Pressing this key repeatedly changes the source for the audio to be viewed by the Audio Scope. The selections are:

VFO-A → *VFO-B* → *EXT* → *VFO-A*

When “EXT” is selected, you can observe the audio wave form of a signal input provided by equipment connected to the **AUDIO IN** jack on the rear panel of the **DMU-2000**.

③ [KEY4(ATT)] Key (Attenuator)

This key permits adjustment of the Audio Scope attenuation. Set the appropriate value based on the received signal.

0 dB → *10 dB* → *20 dB* → *0 dB*

④ [KEY6(LEVEL)] Key

This key permits adjustment of the sensitivity of the Oscilloscope display at the right side of the screen. Adjust the level while viewing the screen, to optimize the setting according to the signal and noise conditions present. Available values are:

0.3 V → *0.1 V* → *1.0 V* → *0.3 V*

⑤ [KEY7(SWEEP)] Key

This key permits adjustment of the sweep time for the Oscilloscope. Adjust this setting while viewing the screen. Available sweep times are:

10 ms → *30 ms* → *100 ms* → *300 ms* → *1 s* → *10 ms*

⑥ [KEY8(DISPLAY)] Key

Press this key briefly to toggle the Function key operations between the “Page Select Keys” and the “Function Keys.”

Press and hold in this key to disable **DMU-2000** control, and return the key buttons to control the **FT-2000/D**, **FT-950**, or **FTdx5000** operations.

AUDIO SCOPE AND OSCILLOSCOPE

USING THE AUDIO SCOPE

The Audio Scope is particularly useful when making adjustments to the transmitter, especially when setting up the Speech Processor and the Parametric Microphone Equalizer.

On receive, you can observe the signal characteristics and quality of the incoming signal. The Waterfall display can be used for precise frequency alignment of incoming signals to correspond with filters used in your computer's sound card or modem. The sweep time (speed) of WF-2 is faster than WF-1, and you can choose the sweep most appropriate for your operating application.

1. By pressing the [KEY2(MODE)] key repeatedly, the Audio Scope mode can be changed. The available selections are:

NORMAL → *WF-1* → *WF-2* → *NORMAL*

“*NORMAL*” is a regular spectrum display.

“*WF-1*” and “*WF-2*” are Waterfall displays, with “*WF-2*” utilizing a faster sweep time.

2. Pressing the [KEY3(SOURCE)] key repeatedly, selects the source of the audio to be viewed on the Audio Scope. The selections are:

VFO-A → *VFO-B* → *EXT* → *VFO-A*

Advice: When “*EXT*” is selected, you can observe the audio wave form of a signal provided by external equipment connected to the **AUDIO IN** jack on the rear panel of the **DMU-2000**.

3. Press the [KEY4(ATT)] key repeatedly, to change the setting for the attenuator. The available settings are:

0.3 V → *0.1 V* → *1.0 V* → *0.3 V*

MANUAL REFERENCE	FT-950 FTdx5000	FT-2000 FT-2000D
[KEY1(xxx)]	[1.8(1)]	[F1(CH-1)]
[KEY2(xxx)]	[3.5(2)]	[F2(CH-2)]
[KEY3(xxx)]	[7(3)]	[F3(CH-3)]
[KEY4(xxx)]	[10(4)]	[F4(CH-4)]
[KEY5(xxx)]	[14(5)]	[F5(MEM)]
[KEY6(xxx)]	[18(6)]	[F6(DEC)]
[KEY7(xxx)]	[21(7)]	[F7(P.BACK)]
[KEY8(xxx)]	[24.5(8)]	[DISPLAY]

Advice: By using this feature, you can conveniently monitor the status of the CONTOUR filter, the performance of the IF Notch, and the WIDTH/SHIFT status.

AUDIO SCOPE SPECIFICATIONS

Frequency Range: 100 Hz - 4 kHz

Frequency Resolution: 20 Hz (Approx.)

Display Range: 80dB (Approx.)

Signal Processing: FFT (Fast Fourier Transformation)

Input Level: 1 Vp-p Input (ADC Max. value)

Attenuator: @0 dB, top edge;

@10 dB, 1 division of shift;

@20 dB, 2 divisions of shift

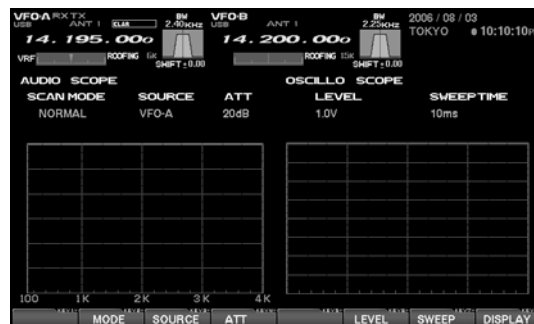

↑ [KEY2(MODE)] Key
↑ [KEY3(SOURCE)] Key
↑ [KEY4(ATT)] Key

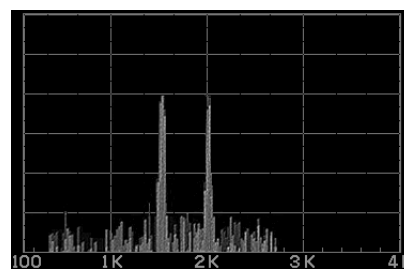

SPECTRUM DISPLAY

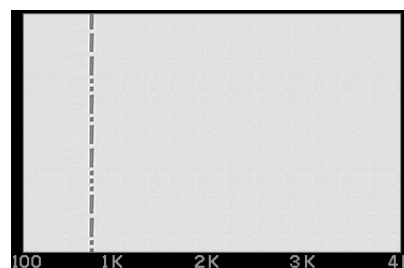

WATERFALL DISPLAY

AUDIO SCOPE AND OSCILLOSCOPE

USING THE OSCILLOSCOPE

The RX waveform can be observed on voice and CW modes. The TX voice waveform can also be observed, allowing optimal adjustments of setup options, and filter settings.

1. Press the **[KEY6(LEVEL)]** key repeatedly, to set the level appropriate for the signal strength being monitored. Available values are:

0.3 V → 0.1 V → 1.0 V → 0.3 V

2. Press the **[KEY7(SWEEP)]** key repeatedly, to set the desired sweep time. Available values are:

10 ms → 30 ms → 100 ms → 300 ms → 1 s → 10 ms

MANUAL REFERENCE	FT-950 FT _{Dx} 5000	FT-2000 FT-2000D
[KEY1(xxx)]	[1.8(1)]	[F1(CH-1)]
[KEY2(xxx)]	[3.5(2)]	[F2(CH-2)]
[KEY3(xxx)]	[7(3)]	[F3(CH-3)]
[KEY4(xxx)]	[10(4)]	[F4(CH-4)]
[KEY5(xxx)]	[14(5)]	[F5(MEM)]
[KEY6(xxx)]	[18(6)]	[F6(DEC)]
[KEY7(xxx)]	[21(7)]	[F7(P.BACK)]
[KEY8(xxx)]	[24.5(8)]	[DISPLAY]

Advice: To monitor the TX waveform, turn on the monitor feature by pressing the **[MONI]** button on the front panel of the transceiver.

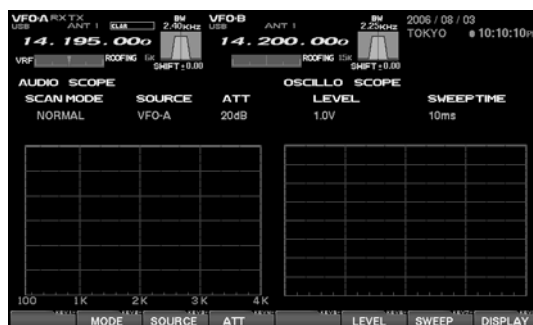

↑ "LEVEL" Select
↑ "SWEEP" Select

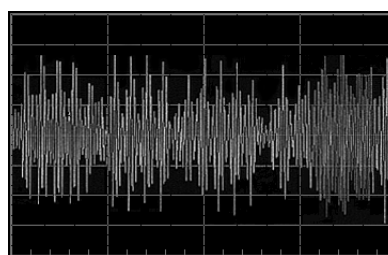

OSCILLOSCOPE DISPLAY

OSCILLOSCOPE SPECIFICATIONS

Frequency Range: 0 - 4 kHz

Sweep Speed: 10/30/100/300/1000ms (adjustable)

Time Base Indication: One frame: 10 divisions (20 gradations) "Sweep time / 20"
500 μ/1.5 m/5 m/15 m/50 m/DIV

Signal Processing: AC Level Detection Synchronizer function

Input Level: 1 V_{p-p} Input (ADC Max. value)

AUDIO SCOPE AND OSCILLOSCOPE

NOTE

LOG BOOK FUNCTION

ABOUT THE LOG BOOK

Using your keyboard (not supplied) connected to the Data Management Unit's rear-panel **KEYBOARD** jack (PS/2 or USB), you can create a Log Book within the DMU-2000, and display it on your monitor. Date, time, frequency, and mode will be automatically stored, and you can save the log data to the Compact Flash card for archive purposes.

If the "Log Book" screen does not initially appear, press the **[KEY8(DISPLAY)]** key to toggle the Function key operations to "Page Select Keys," then press the **[KEY4(LOGBOOK)]** key briefly to display the "Log Book" screen. Next, press the **[KEY8(DISPLAY)]** key again to toggle the Function key operations to the "Function Keys."

EXPLANATION OF THE FUNCTION KEYS ON THE LOG BOOK SCREEN

① [KEY1(FUNC)] Key

② [KEY2(▼)] Key

③ [KEY3(▲)] Key

④ [KEY4(EDIT)] Key

⑤ [KEY7(SAVE/LOAD)] Key

⑥ [KEY8(DISPLAY)] Key

① [KEY1(FUNC)] Key

You may use the "CHECK" function to check the log to see if a QSO has been made previously with the logged station, and you may also create a summary of QSOs by band and mode by pressing this key. The log may be viewed solely for the current operator, or for all operators registered into the Logbook and saved on the CF card.

② [KEY2(▼)] Key

Press this key to shift to the log line below the current one.

③ [KEY3(▲)] Key

Press this key to shift to the log line above the current one.

④ [KEY4(EDIT)] Key

Press this key to enable editing of previously-stored log data.

⑤ [KEY7(SAVE/LOAD)] Key

Press this key to engage the screen that allows you to manage log data to be saved.

⑥ [KEY8(DISPLAY)] Key

Press this key briefly to switch the Function key operations between the "Page Select Keys" and the "Function Keys."

Press and hold in this key to disable **DMU-2000** control, and return the key buttons to control of the **FT-2000/D**, **FT-950**, or **FTdx5000** operations.

LOG BOOK FUNCTION

LOG BOOK EXAMPLE

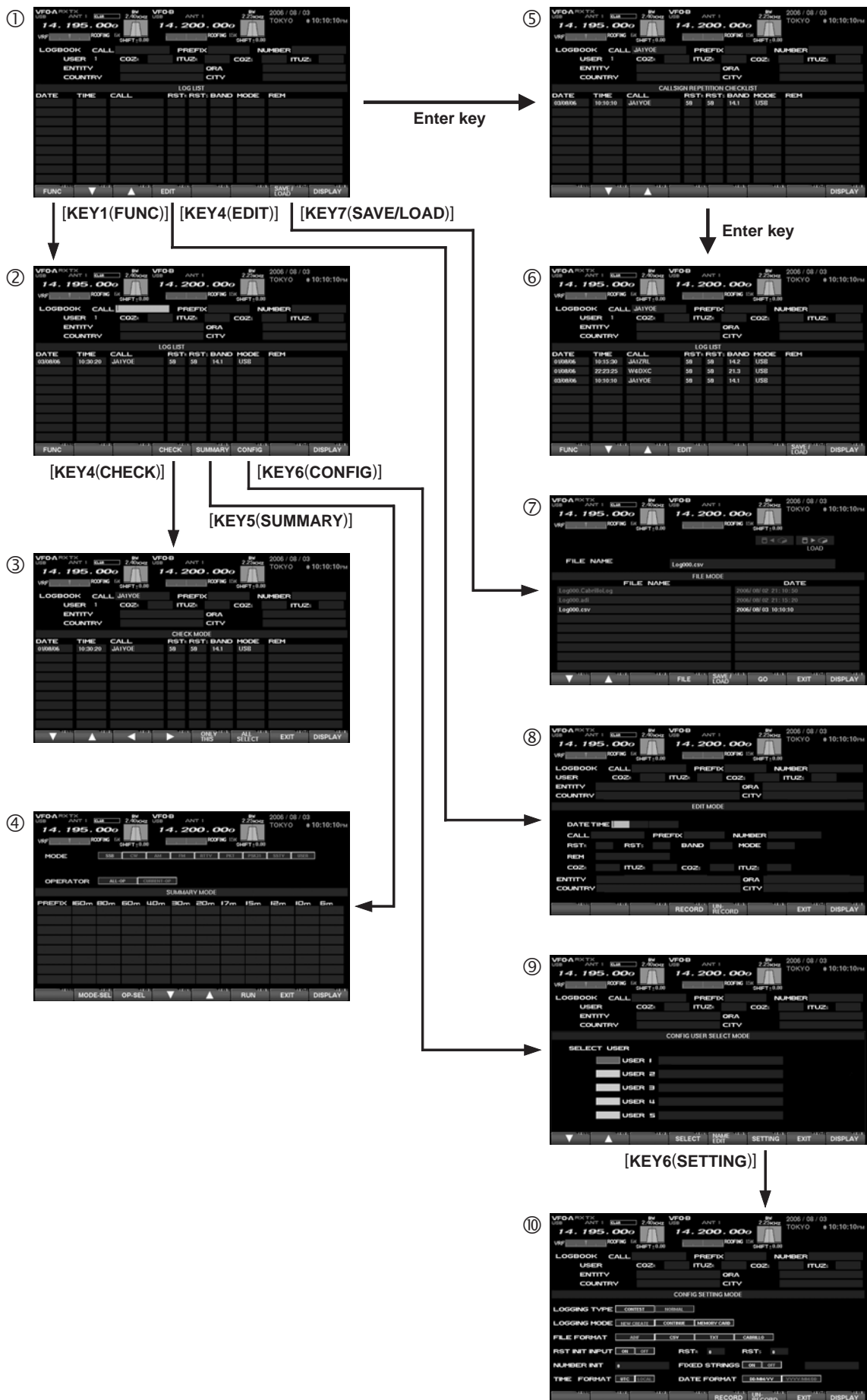

LOG BOOK FUNCTION

CONFIG SETTING

Up to five users may be registered into the Logbook. For use in a contest or otherwise, the settings for each operator may be stored for later recall when that operator signs on. The operator's name and callsign identification may be entered into the NAME column.

1. Referring to Figure ① on page 31, press the [KEY6(CONFIG)] key to engage the “**CONFIG USER SELECT MODE**,” then the [F1(▼)]/[F2(▲)] keys to utilize the “**SELECT USER**” function.
2. When you want to register a new user, or change the name of an existing user, press the [KEY5(NAME EDIT)] key and input the call sign and/or other information.
3. Press the [KEY5(NAME EDIT)] key again.
4. Press the [KEY6(SETTING)] key to engage the “**CONFIG SETTING MODE**,” then use the keyboard’s arrow keys to navigate to the needed fields. Please see the discussion on the next page for details of the “**CONFIG SETTING MODE**” mode.
5. Press the [KEY5(RECORD)] key to register. If you want to un-do the registration, press [KEY6(UN-RECORD)] key.

MANUAL REFERENCE	FT-950 FT Dx5000	FT-2000 FT-2000D
[KEY1(xxx)]	[1.8(1)]	[F1(CH-1)]
[KEY2(xxx)]	[3.5(2)]	[F2(CH-2)]
[KEY3(xxx)]	[7(3)]	[F3(CH-3)]
[KEY4(xxx)]	[10(4)]	[F4(CH-4)]
[KEY5(xxx)]	[14(5)]	[F5(MEM)]
[KEY6(xxx)]	[18(6)]	[F6(DEC)]
[KEY7(xxx)]	[21(7)]	[F7(P.BACK)]
[KEY8(xxx)]	[24.5(8)]	[DISPLAY]

Advice: If no identification entry is performed, the log will register you as “**USER1.**”

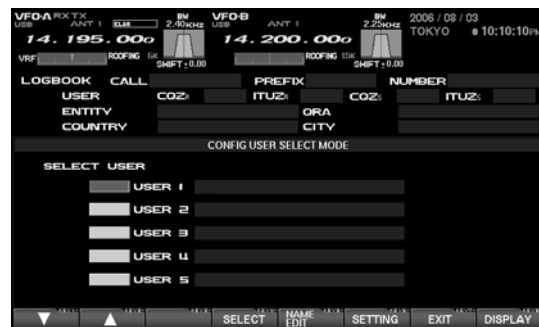

CONFIG USER SELECT MODE

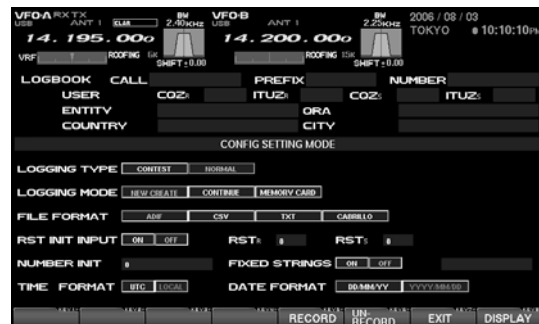

CONFIG SETTING MODE

CONFIG SETTING

CONFIG SETTING MODE SETUP

LOGGING TYPE (Setup of Log preferences)

CONTEST: This is a concise log format, with only the Callsign, RST, and REM (Remarks) being entered by the operator. The Date, Time, Band, and Mode will be automatically entered and saved.

NORMAL: Besides the above information from the Contest log format, you can enter the Country, City, Name, and other data.

In addition to the call sign, RST and REM, COUNTRY, CITY QRA, etc. data can be added.

All of the DATE, TIME, CBAND, CMODE are automatically saved; once again, the Date, Time, Band, and Mode will automatically be entered and saved.

LOGGING MODE (Logging Operational Mode)

NEW CREATE: Create a new Log Book.

CONTINUE: Add data to current log book.

MEMORY CARD: Download (read) log data from the CF Card (see page 34 for details).

FILE FORMAT (Set up the file format for the log data)

ADIF: A worldwide standard format for DX contest log data.

CSV: Comma Separated Values format.

TXT: Text format.

CABRILLO: Worldwide standard format used for electronic submissions of Contest logs.

RST INIT INPUT (RST Automatic Input)

ON: Automatic filling in of the RSTR and RSTS (RST Received/Sent) reports is enabled. Manual correction of individual log lines is, of course, possible.

OFF: In CW mode, "599" will be automatically entered, and on other modes "59" will be automatically entered. You may correct these reports manually via the keyboard.

NUMBER INIT (Setting the Initial Sequential Number)

The initial Contest Number (or other sequential number to be assigned to each QSO) is entered here. The automatic entry and transmission of the Contest Number will dramatically reduce fatigue over many hours of operation.

FIXED STRINGS (Contest Number/Multiplier Memo On/Off Setup)

ON: In a CW contest, this is the area used for enabling input of multiple "memo" columns of data that will be sent automatically, thus reducing fatigue.

OFF: If there is no need for multiple "memo" input columns, set this to Off.

TIME FORMAT (Conversion of UTC or Local Time for Logbook Time)

When log entry is done in LOCAL (LOCAL TIME-1), the log will automatically convert the time to UTC.

DATE FORMAT (Setup of Date Format to be day/month/year or year/month/day)

The Logbook can be set up for two different formats. When set to DD/MM/YY, March 28, 2005 will be formatted as 28/03/05. If the format selected is YYYY/MM/DD, the same date will be formatted as 2005/03/08.

LOG BOOK FUNCTION

LOG BOOK DATA INPUT

Log data may be entered by the user. Depending on the user (CONFIG) setup for “LOGGING TYPE,” there are two logging modes: In the “CONTEST” mode, the operator just enters the callsign, signal report, and the REM (“remarks”) fields, and the Date/Time/Band/Mode are all entered automatically. In the “NORMAL” mode, additional information may be entered, such as the Country, City, and Name. Up to 500 stations may be stored into a file.

Please enter the log data in accordance with the example in the illustration.

Advice: Before you start logging, we recommend that you perform the **CONFIG SETTING MODE** procedure within the User setup (CONFIG) protocol.

1. Referring to the Figure ① on page 31, use your keyboard to enter the callsign in the “**CALL**” field. Then press the keyboard’s [ENTER] key.
2. The callsign will be checked against the previous entries to see if it is a duplicate; if so, the “**CALLSIGN REPETITION CHECKLIST**” will open, listing this and any other duplicates. During the QSO, if you wish to delete the callsign and other information for this line, just press the keyboard’s [ESC] key.
3. Enter all desired data in accordance with the example in the picture. When finished, press the keyboard [ENTER] key.

Note: In order to ensure preservation of log data, be sure to Save the data frequently. It is always a good idea to maintain a paper archive copy of log data. Vertex Standard specifically disclaims responsibility for any liability arising from the loss of log data.



CALLSIGN REPETITION CHECK LIST

Advice: When entering the Zone via the “**ITUZR**” field, pressing the key-board [ENTER] key will move you to the CQ Zone (**CQZR**); from there, use the key-board’s [▶] key to navigate back to the “**ITUZR**” field, if desired.

When doing input of the “**PREFIX**,” “**CQZR**” (or “**ITUZR**”), “**ENTITY**,” and “**QRA**” data, please set the “**LOGGING TYPE**” to “**NORMAL**” beforehand. This will allow you to move from column to column by pressing the key-board’s [ENTER] key. In addition, when (for example) entering the “**PREFIX**” and pressing the key-board’s [ENTER] key, the “**PREFIX SELECT LIST**” will appear, and the “**ENTITY**” and “**CQZR**” (or “**ITUZR**”) will automatically be entered.

LOG BOOK PREVIOUS-QSO CHECK (CHECK)

It is possible to search the log for previous QSOs with a particular station. When a log entry of interest is found, you may edit the information on that line, if you like.

1. Referring to the Figure ① on page 31, enter the desired callsign into the “CALL” field.
2. Press the [KEY4(CHECK)] key to show a list of any previous QSOs with the specified station within the current log. Any previous QSOs will appear on a “CHECK MODE” list.
3. Use the [KEY1(▼)], [KEY2(▲)], [KEY3(◀)], and [KEY4(▶)] keys to scroll through the data on the “CHECK MODE” list.



“CHECK MODE” LIST

MANUAL REFERENCE	FT-950 FTdx5000	FT-2000 FT-2000D
[KEY1(XXX)]	[1.8(1)]	[F1(CH-1)]
[KEY2(XXX)]	[3.5(2)]	[F2(CH-2)]
[KEY3(XXX)]	[7(3)]	[F3(CH-3)]
[KEY4(XXX)]	[10(4)]	[F4(CH-4)]
[KEY5(XXX)]	[14(5)]	[F5(MEM)]
[KEY6(XXX)]	[18(6)]	[F6(DEC)]
[KEY7(XXX)]	[21(7)]	[F7(P.BACK)]
[KEY8(XXX)]	[24.5(8)]	[DISPLAY]

Quick Point: In the Step 2 above, before doing a check for a duplicate QSO, a copy is made of the QSO record, and you may then do editing of that record. Use the [KEY1(▼)], [KEY2(▲)], [KEY3(◀)], and [KEY4(▶)] keys to select an item from among “CALL,” “RST,” “BAND,” “MODE,” and “REM,” when you press the [KEY5(ONLY THIS)] key you’ll copy only that item. When you press the [KEY7(EXIT)] key, the display image changes to what you see on page 31; press the keyboard’s [ENTER] key to do a duplicate check, and press the [ENTER] key once more to return to the log input page and copy the data.

If you select a line of data using the [KEY1(▼)] and [KEY2(▲)] keys, pressing the [KEY6(ALL SELECT)] key followed by [KEY7(ENTER)] key will cause the display image to change to what you see on page 31, and you may now press the keyboard’s [ENTER] key to do a duplicate check. Press the [ENTER] key once more to return to the log input page and copy the data to that page (however, the “NUMBER,” “RST,” “BAND,” and “MODE” data will not be copied).

EDITING LOG BOOK ENTRIES

Previously-entered log data may be edited later, if desired.

1. Referring to Figure ① on page 31, press the [KEY2(▼)] or [KEY3(▲)] key to select the log data to be edited, then press the [KEY4(EDIT)] key to open the “EDIT MODE” list.
2. Now you may use the arrow keys on your keyboard to move the highlighted area through the log.
3. Use the keyboard to change data within the currently highlighted area.
4. Press the [KEY4(RECORD)] key when you are finished editing, to save the entries you have worked on. If you do not wish to save your changes, press the [KEY5(UN-RECORD)] key instead.



“EDIT MODE” LIST

Advice: Data may easily be deleted, if you make a mistake, enter duplicate data accidentally, etc.

To erase data, use steps 1 and 2 above to select the data to be erased. Then press the keyboard [ESC] key; the data will be deleted. Press [KEY4(RECORD)] to return to the screen depicted on page 34 and end this procedure.

LOG BOOK FUNCTION

SAVING LOG DATA

Log data can be saved to the supplied Compact Flash (CF) card.

1. Referring to Figure ① on page 31, press the [KEY7(SAVE/LOAD)] key to move to the Save/Load page.
2. Press the [F5(SAVE/LOAD)] key to choose the "Save" protocol.



3. Input the desired FILE NAME, and press the [KEY6(GO)] key to save the data in the CF card.

Note: Be sure not to delete the file "extension" to the file name, when entering the file name. If the extension is missing, it will not be possible to load log data.

If the ERROR message "CF CARD IS NOT READY" appears on the display, please confirm that the CF card is inserted correctly into its slot.

Please note: When memory data is saved to the CF card, any file with the same name as the current file will be revised (overwritten), and the previous data will be deleted.



"SAVE/LOAD" MODE

Advice: The user configuration protocol (CONFIG) allows you to specify the file format that is used for saving log data. The available formats are:

- ADIF (International Log Format) **adf**
- CSV (Cursor-Limited Values) **csv**
- TXT (Tab-Limited Values) **txt**
- CABRILLO (International Log Format) **cabrillolog**

LOADING LOG DATA (LOAD)

You may load log data from a CF card into your **DMU-2000** (for example, an archive copy, or a log from a different **DMU-2000** or **FT dx 9000** Series Transceiver). Before starting, be sure the CF card containing the log data has been inserted into the CF Card Slot.

1. Referring to Figure ① on page 31, press the [KEY7(SAVE/LOAD)] key to engage the Save/Load mode.
2. Press the [KEY5(SAVE/LOAD)] key to engage the LOAD protocol.



3. Use the [KEY1(▼)] and [KEY2(▲)] keys to select the file you wish to upload to the transceiver, then press the [KEY6(GO)] key to load the file.



"SAVE/LOAD" MODE

Advice: When entering the file name, be sure not to delete the file "extension". A missing extension will make it impossible to load log data.

If the ERROR message "CF CARD IS NOT READY" appears on the display, please confirm that the CF card is inserted correctly into its slot.

When memory data is loaded from the CF card, the current memories stored in the **DMU-2000** will be overwritten, and the previous data is erased. We recommend that you save and download the current memory data to the CF card, if you want to use it again later.

MANUAL REFERENCE	FT-950 FT-DX5000	FT-2000 FT-2000D
[KEY1(XXX)]	[1.8(1)]	[F1(CH-1)]
[KEY2(XXX)]	[3.5(2)]	[F2(CH-2)]
[KEY3(XXX)]	[7(3)]	[F3(CH-3)]
[KEY4(XXX)]	[10(4)]	[F4(CH-4)]
[KEY5(XXX)]	[14(5)]	[F5(MEM)]
[KEY6(XXX)]	[18(6)]	[F6(DEC)]
[KEY7(XXX)]	[21(7)]	[F7(P.BACK)]
[KEY8(XXX)]	[24.5(8)]	[DISPLAY]

SUMMARY CHECK

You may do a band-by band, a mode-by mode, or an “all log” summary of your log data.

MODE-BASED SUMMARY CHECK

1. Referring to Figure ② on page 31, press the [KEY5(SUMMARY)] key to bring up the “SUMMARY MODE” page, and you may then press the [KEY2(MODE-SEL)] key and select the desired mode, using the keyboard’s arrow ([◀] or [▶]) keys.
2. When you press the [KEY6(RUN)] key, the summary list for the selected mode will be displayed.
3. Use the [KEY4(▼)] and [KEY5(▲)] keys to scroll through the summary list.

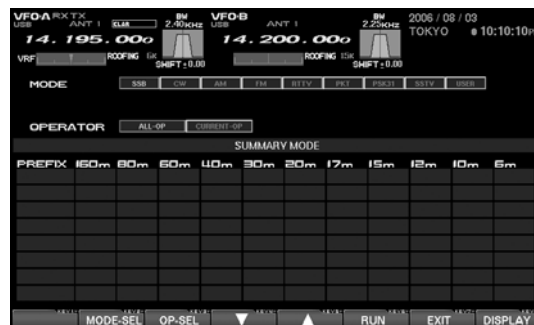

“SUMMARY MODE” PAGE

OPERATOR-BASED SUMMARY CHECK

1. Referring to Figure ② on page 31, press the [KEY5(SUMMARY)] key to display the “SUMMARY MODE” page, then press the [KEY3(OP-SEL)] key and then use the keyboard arrow ([◀] or [▶]) keys to select “ALL-OP” or “CURRENT OP” as desired.
 - ALL-OP:** All log data from all the registered operators will be displayed.
 - CURRENT OP:** Only the log data from the current operator will be displayed.
2. Press the [KEY6(RUN)] key to display the summary list for the selected operator, or all operators.
3. Use the [KEY4(▼)] and [KEY5(▲)] keys to scroll through the summary list.

Note: The Summary Check function requires that “NORMAL” be selected as the “Log Type” before you start, and only logs containing the PREFIX may be used for this function.

Files saved in either “.CSV” or “.TXT” formats are capable of letting you perform the “Summary Check” function.

MANUAL REFERENCE	FT-950 FT-Dx5000	FT-2000 FT-2000D
[KEY1(xxx)]	[1.8(1)]	[F1(CH-1)]
[KEY2(xxx)]	[3.5(2)]	[F2(CH-2)]
[KEY3(xxx)]	[7(3)]	[F3(CH-3)]
[KEY4(xxx)]	[10(4)]	[F4(CH-4)]
[KEY5(xxx)]	[14(5)]	[F5(MEM)]
[KEY6(xxx)]	[18(6)]	[F6(DEC)]
[KEY7(xxx)]	[21(7)]	[F7(P.BACK)]
[KEY8(xxx)]	[24.5(8)]	[DISPLAY]

TEMPERATURE / SWR INDICATION

ABOUT THE TEMPERATURE/SWR INDICATION

It is possible to display the VDD (TX Final Amplifier) voltage, bias voltage, the temperature of the heat sink of the final devices, and the (swept) SWR characteristics/performance of the antenna connected, all on the same Display screen.

If the “Temperature/SWR” screen does not initially appear, press the [KEY8(DISPLAY)] key to switch the Function key’s function to “Page Select Key,” then press the [KEY5(SWR)] key briefly to display the “Temperature/SWR” screen. Next, press the [KEY8(DISPLAY)] key again to switch the Function key’s function to the “Function Key.”

EXPLANATION OF THE FUNCTION KEYS ON THE TEMPERATURE/SWR INDICATION SCREEN

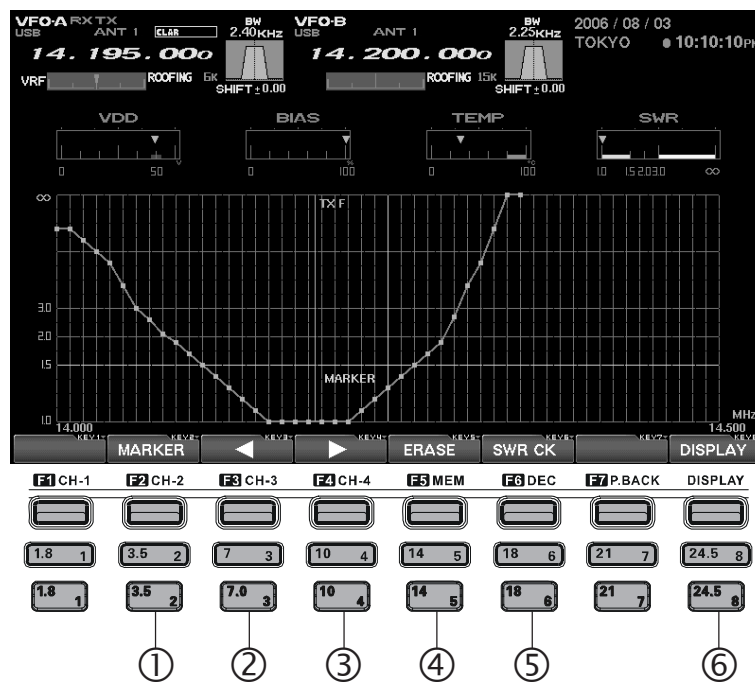

① [KEY2(MARKER)] Key

This key turns the marker on the SWR characteristic graph on and off.

The marker lets you identify quickly the frequency on which a particular SWR reading is being observed.

② [KEY3(◀)] Key

This key moves the marker cursor to the left.

③ [KEY4(▶)] Key

This key moves the marker cursor to the right.

④ [KEY5(ERASE)] Key

Press this key when you want to clear the measured SWR at the marker’s current point.

⑤ [KEY6(SWR CK)] Key

To check the SWR on a particular frequency, rotate the Main Tuning Dial knob, and set the frequency to be measured. Now press the [KEY6(SWR CK)] key; the SWR will be measured and the result will be displayed on the screen.

⑥ [KEY8(DISPLAY)] Key

Press this key briefly to switch the Function key’s function between the “Page Select Key” and the “Function Key.”

Press and hold in this key to disable the Function keys (except this key).

TEMPERATURE / SWR INDICATION

GRAPHIC METER DISPLAYS

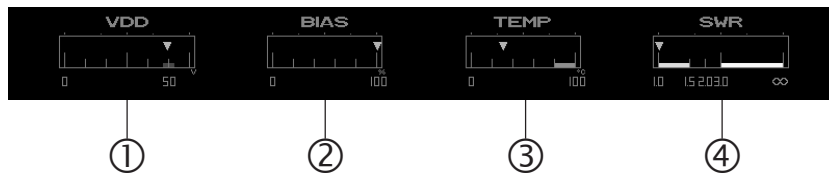

① VDD

The drain voltage of the final FETs is measured and displayed here.

In the **FT-2000** (100 W version) and **FT-950**, the measurement range is 0 ~ 18 V, and the proper voltage is around 13.8 V. On TX, if around 13.8 V is displayed, the transceiver is operating normally.

In the **FT-2000D** (200 W version) and **FTdx5000**, the measurement range is 0 ~ 60 V, and the proper voltage is around 50 V. On TX, if around 50 V is displayed, the transceiver is operating normally.

② BIAS

While operating with the Class-A on the **FT-2000D** (200 W version) and **FTdx5000**, the bias is changed via the Menu item “**141 tGEN BIAS**” (**FT-2000D**) or “**169 TGEN BIAS**” (**FTdx5000**) from Class-A to Class-AB, this indication can be used to observe the current setting. The indication is 0 ~ 100 % and “0 %” means Class-AB, while “100 %” means Class-A.

Even if the Bias is varied, the RF output will not change (up to the 75 Watts of maximum power under Class-A), and you can change the bias safely even when you are using a linear amplifier.

In the **FT-2000** (100 W version) and **FT-950**, this indicator always shows “0 %.”

③ TEMP

This indicates the temperature (measured) of the final amplifier FETs’ heat sink.

The measured temperature range of this meter is 0 ~ 100 °C, and above 80 °C is the “Red Zone” temperature range to be avoided, so as to ensure a safe operating temperature range. When the temperature rises above 80 °C, the fan speed will increase by a factor of four, providing a significant increase in air flow. The heat sink temperature may rise appreciably during Class-A operation on the **FT-2000D** (200 W version) and **FTdx5000**, especially if the ambient temperature is warm, and we recommend that you monitor the temperature during Class-A transmission, adjusting the Bias control downward (more toward Class-AB) if excessive heating is observed. A lower bias level will cause less heat to be dissipated, thus reducing the heat sink temperature.

④ SWR

This displays the SWR characteristic of the amateur band that you are currently using, with points along the graph indicating the frequencies that have been measured.

TEMPERATURE / SWR INDICATION

SWEPT SWR DISPLAY

It is possible to show the SWR characteristics and antenna performance on a graph by measuring the SWR at various points across an amateur band.

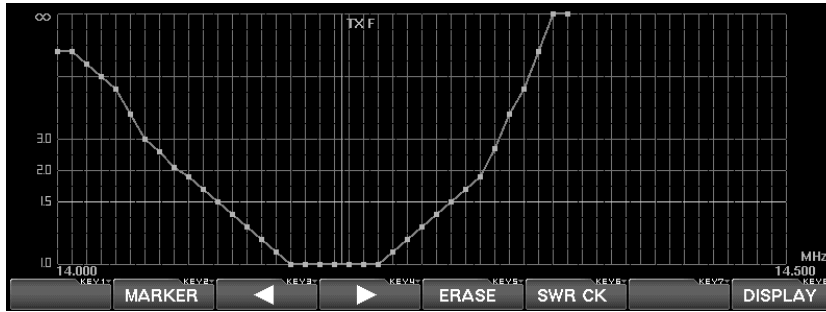

In order to measure the SWR of the antenna system correctly, please turn off the antenna tuner before measuring the SWR.

1. Please confirm that the RF output is over 10 Watts. In order to measure the SWR correctly, 10 Watts of RF output will be required. The TX RF output may be adjusted using the [RF PWR] knob.
2. Please confirm that the test transmission will not cause QRM to other stations (be sure to ask if the frequency is clear, and identify in accordance with regulations). Then press the [KEY6(SWR CK)] key.
3. Perform the above procedure several times across the band, and the SWR measured at the various test frequencies will automatically be plotted on the chart, creating a performance characteristic graph for the current frequency range.

Advice: For the purposes of plotting the SWR across the band, the resolution of the graph is every 10 kHz on the 1.8 ~ 24.9 MHz bands, and 100 kHz on the 28/50 MHz bands.

If a measurement is done on the same frequency as where a previous measurement was made, the old data will be cleared and the new measurement data will replace it.

Always observe proper operating courtesy to others, and check to be sure the frequency is clear before performing any SWR measurements.

MANUAL REFERENCE	FT-950 FT _{DX} 5000	FT-2000 FT-2000D
[KEY1(xxx)]	[1.8(1)]	[F1(CH-1)]
[KEY2(xxx)]	[3.5(2)]	[F2(CH-2)]
[KEY3(xxx)]	[7(3)]	[F3(CH-3)]
[KEY4(xxx)]	[10(4)]	[F4(CH-4)]
[KEY5(xxx)]	[14(5)]	[F5(MEM)]
[KEY6(xxx)]	[18(6)]	[F6(DEC)]
[KEY7(xxx)]	[21(7)]	[F7(P.BACK)]
[KEY8(xxx)]	[24.5(8)]	[DISPLAY]

TEMPERATURE / SWR INDICATION

USING THE MARKER ON THE SWR GRAPH

It is possible to read the measured SWR value by placing the marker onto the desired frequency (measurement test point) of the SWR graph.

1. Press the [KEY2(MARKER)] key to turn the marker function on; the marker cursor will be displayed.
2. Use the [KEY3(◀)] and [KEY4(▶)] keys to move the marker line and select the desired frequency for which you want to read the previously-measured SWR.

Advice: Please use an antenna with the SWR below 1.5:1. If the SWR is over 1.5:1, the final protection circuit activates, and the RF output power may be reduced.

If the SWR is over 3.0 in the amateur band, there is a possibility that the coaxial cable or the antenna itself (antenna system) may have some problem. Please take the necessary corrective action so as to ensure optimum, safe performance in your station.

The antenna tuner in the radio can match the SWR between the transceiver and the antenna; however, keep in mind that this is not affecting the SWR at the antenna feedpoint itself. In cases of higher-than-desirable SWR, we recommend corrective action be taken at the antenna itself.

When you want to clear the measured SWR value at the marker test point, press the [KEY2(MARKER)] key.

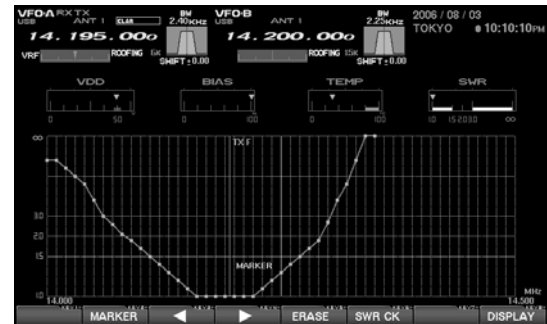

MANUAL REFERENCE	FT-950 FT-DX5000	FT-2000 FT-2000D
[KEY1(XXX)]	[1.8(1)]	[F1(CH-1)]
[KEY2(XXX)]	[3.5(2)]	[F2(CH-2)]
[KEY3(XXX)]	[7(3)]	[F3(CH-3)]
[KEY4(XXX)]	[10(4)]	[F4(CH-4)]
[KEY5(XXX)]	[14(5)]	[F5(MEM)]
[KEY6(XXX)]	[18(6)]	[F6(DEC)]
[KEY7(XXX)]	[21(7)]	[F7(P.BACK)]
[KEY8(XXX)]	[24.5(8)]	[DISPLAY]

GREAT CIRCLE MAP / ROTATOR CONTROL FUNCTION

ABOUT THE GREAT CIRCLE MAP / ROTATOR CONTROL FUNCTION SCREEN

In order to direct the antenna to the desired/opposite station, a Great Circle Map can be displayed on the screen. This Great Circle map will show your location at the center of the map, and you can easily recognize and confirm the direction your antenna should be pointed to work a station elsewhere in the world.

In addition, when a Yaesu Rotator (**G-800DXA**, **G-1000DXA**, or **G-2800DXA**) is connected to the transceiver, the transceiver can control the direction of the rotation, rotation speed, etc. on the display screen. In this case, the rotator has to be connected to the transceiver via the optional cable T9101556, available from your YAESU dealer.

If the “Rotator Control” screen does not initially appear, press the [KEY8(DISPLAY)] key to switch the Function key’s function to “Page Select Key,” then press the [KEY6(ROTATOR)] key briefly to display the “Rotator Control” screen. Next, press the [KEY8(DISPLAY)] key again to switch the Function key’s function to the “Function Key.”

EXPLANATION OF THE FUNCTION KEYS ON THE GREAT CIRCLE MAP/ROTATOR CONTROL SCREEN

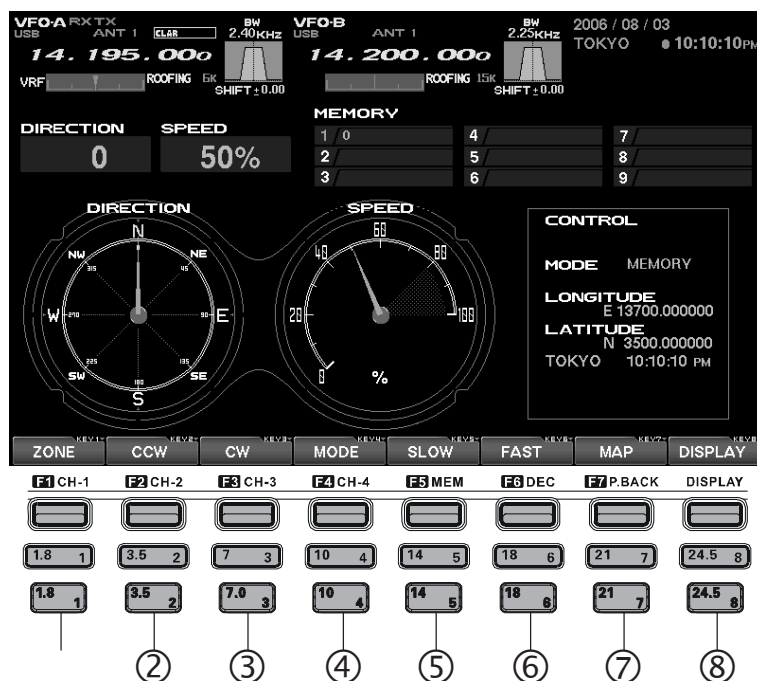

① [KEY1(ZONE)] Key

This key moves you to a screen used for input of the location of the other station. When the country name and the city name are entered, your location and the other station’s location will be connected with a line and displayed on the Great Circle map (short path only). The location of the other station can be set when Rotator control is in the manual mode.

Press the [KEY4(MODE)] key as needed to select the manual mode. The mode is indicated in the middle of the Display.

② [KEY2(CCW)] Key

When a Yaesu Rotator (**G-800DXA**, **G-1000DXA**, or **G-2800DXA**) is connected to the transceiver, press this key to rotate the antenna in the CCW (counter clockwise) direction.

③ [KEY3(CW)] Key

When a Yaesu Rotator (**G-800DXA**, **G-1000DXA**, or **G-2800DXA**) is connected to the transceiver, press this key to rotate the antenna in the CW (clockwise) direction.

GREAT CIRCLE MAP / ROTATOR CONTROL FUNCTION

EXPLANATION OF THE FUNCTION KEYS ON THE GREAT CIRCLE MAP/ROTATOR CONTROL SCREEN

④ [KEY4(MODE)] Key

By pressing this key, the rotation control mode can be selected. With every momentary press, the mode changes as shown below. The mode is indicated in the middle of the Display.

MANUAL → *PRESET* → *MEMORY* → *MANUAL*

MANUAL: CW/CCW control is performed manually.

PRESET: Rotation to the “PRESET” direction is selected.

MEMORY: Rotation to one of the stored rotation memories is selected.



MODE Indicator

⑤ [KEY5(SLOW)] Key

Use this key to reduce the antenna rotation speed. Normally, you will use the “100 %” value; once 100 % is selected, you typically will not need to use this key.

⑥ [KEY6(FAST)] Key

Use this key when you want to increase the antenna rotation speed. Normally, you will use the “100 %” value; once 100 % is selected, you typically will not need to use this key.

⑦ [KEY7(MAP)] Key

This key switches the Display between the Great Circle Map and the regular Rotator Control compass display.

Advice: If the Great Circle display is utilized, you probably already know the approximate location of the other station on the map; so even if the country name and the city name are not entered into the radio, the Great Circle Map provides a convenient tool for rotating the antenna to the optimum heading.

If your own location is not indicated at the center of the Great Circle Map, please set the local time (which registers the location where the radio is operated). If this is not done, the various functions of the World clock and Great Circle Map will not function correctly. Regarding the setting of the Local time, please see the “PLEASE READ THIS FIRST” section.

⑧ [KEY8(DISPLAY)] Key

Press this key briefly to switch the Function key’s function between the “Page Select Key” and the “Function Key.”

Press and hold in this key to disable the Function keys (except this key).

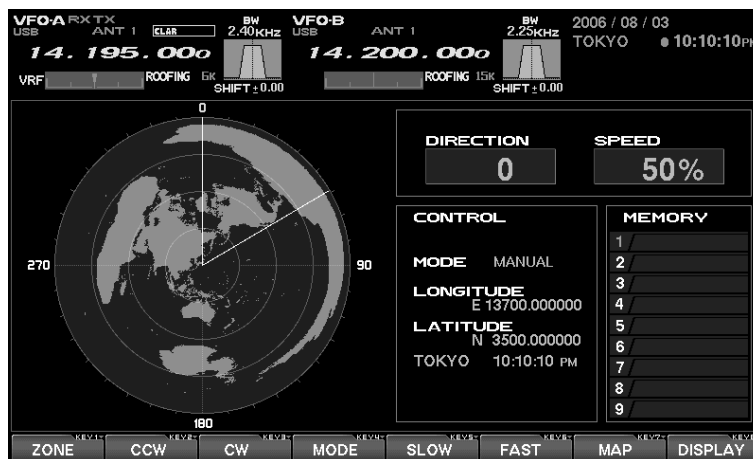

“GREAT CIRCLE MAP” DISPLAY

IMPORTANT NOTE

The following Menu Item must be set to match the starting point of your rotator control indicator needle. The default setting is zero (north). If your controller starting point is south, then the menu must be set to 180 degrees. If not set properly the **DMU-2000** display will not show the correct direction.

FT-2000: “012 diSP RTR STU” (see page 112 of the **FT-2000** Operation Manual)

FT-2000D: “012 diSP RTR STU” (see page 116 of the **FT-2000D** Operation Manual)

FT-950: “011 DISP RTR STU” (see page 109 of the **FT-950** Operation Manual)

FTdx5000: “014 DISP RTR STU” (see page 122 of the **FTdx5000** Operation Manual)

GREAT CIRCLE MAP / ROTATOR CONTROL FUNCTION

MANUAL MODE

It is possible to operate/control the rotator manually. If the other station's location has been entered, the location of the other station and yours will be connected with a line on the Great Circle Map, and you can rotate the antenna manually to the heading of the other station.

MANUAL OPERATION

Use the [KEY2(CCW)] key to rotate the antenna counterclockwise, or the [KEY3(CW)] key to rotate the antenna clockwise.



"REGULAR COMPASS" DISPLAY

MANUAL OPERATION (USING THE GREAT CIRCLE MAP)

1. Press the [KEY4(MODE)] key, as necessary, to select the "PRESET" or "MANUAL" mode. The mode is indicated in the middle of the Display.
2. Press the [KEY7(MAP)] key to display the Great Circle Map on the screen. If you know the approximate location of the country of the other station, rotate your antenna in the appropriate direction while observing the indication on the Great Circle Map.
3. If you want to display a station on the Great Circle Map, start by pressing the [KEY1(ZONE)] key; the World Map's zones will be displayed.



"GREAT CIRCLE MAP" DISPLAY

Select the Zone of the other station using the [KEY1(▼)], [KEY2(▲)], [KEY3(◀)], and [KEY4(▶)] keys, then press the [KEY7(SELECT)] key briefly. The list of the countries in the selected Zone will be shown.

Select the country name of the other station by pressing the [KEY1(▼)], [KEY2(▲)], [KEY3(◀)], and [KEY4(▶)] keys, then press the [KEY7(SELECT)] key momentarily.

Now, the list of the city names within the selected country will appear, and you will need to select one of the city names by pressing the [KEY1(▼)], [KEY2(▲)], [KEY3(◀)], and [KEY4(▶)] keys. Now press the [KEY7(SELECT)] key.

Note; in some countries, there may be only one city in the country; select that one city anyway.

4. Press the [KEY8(EXIT)] key. Automatically the screen will revert to the Great Circle Map, and the location of the other station will plotted on the map, connected by a line to your location via the short path.
5. Use the [KEY2(CCW)] and [KEY3(CW)] keys to rotate your antenna system to the direction just plotted on the Display.

MANUAL REFERENCE	FT-950 FTDX5000	FT-2000 FT-2000D
[KEY1(▼)]	[1.8(1)]	[F1(CH-1)]
[KEY2(▲)]	[3.5(2)]	[F2(CH-2)]
[KEY3(◀)]	[7(3)]	[F3(CH-3)]
[KEY4(▶)]	[10(4)]	[F4(CH-4)]
[KEY5(▼)]	[14(5)]	[F5(MEM)]
[KEY6(▲)]	[18(6)]	[F6(DEC)]
[KEY7(▼)]	[21(7)]	[F7(P.BACK)]
[KEY8(▼)]	[24.5(8)]	[DISPLAY]

GREAT CIRCLE MAP / ROTATOR CONTROL FUNCTION

PRESET MODE

The Preset mode lets you set the desired heading of the rotator in advance, so you can automatically rotate your Yaesu rotator to the designated heading. Use of a Yaesu Rotator (**G-800DXA**, **G-1000DXA**, or **G-2800DXA**) requires the connection of the optional T9101556 cable to the connector located on the back of the transceiver.

1. Press the **[KEY4(MODE)]** key, as necessary, to select the **"PRESET"** mode.
2. Press the **[KEY7(MAP)]** key, if necessary, to bring up the Great Circle Map screen.
3. Press the **[KEY2(CCW)]** or **[KEY3(CW)]** key to set the Preset pointer to the heading of the other station's location.
4. Press the **[KEY5(START)]** key to engage hands-free rotation to the beam heading you just set up in the previous step.

You may stop the rotation manually by pressing the **[KEY5(START)]** key again.

MANUAL REFERENCE	FT-950 FT _{Dx} 5000	FT-2000 FT-2000D
[KEY1(XXX)]	[1.8(1)]	[F1(CH-1)]
[KEY2(XXX)]	[3.5(2)]	[F2(CH-2)]
[KEY3(XXX)]	[7(3)]	[F3(CH-3)]
[KEY4(XXX)]	[10(4)]	[F4(CH-4)]
[KEY5(XXX)]	[14(5)]	[F5(MEM)]
[KEY6(XXX)]	[18(6)]	[F6(DEC)]
[KEY7(XXX)]	[21(7)]	[F7(P.BACK)]
[KEY8(XXX)]	[24.5(8)]	[DISPLAY]

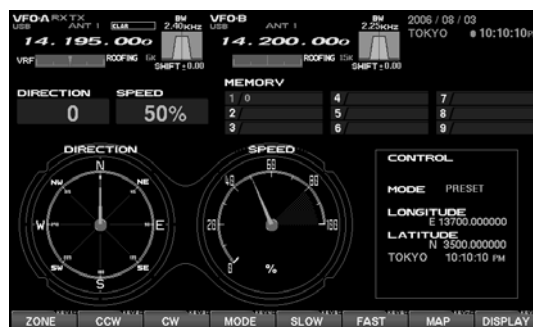

"REGULAR COMPASS" DISPLAY



"GREAT CIRCLE MAP" DISPLAY

GREAT CIRCLE MAP / ROTATOR CONTROL FUNCTION

MEMORY MODE

It is possible to rotate the antenna automatically to headings, which you store into memory in advance. Use of a Yaesu Rotator (**G-800DXA**, **G-1000DXA**, or **G-2800DXA**) requires the connection of the optional T9101556 cable to the connector located on the back of the transceiver.

PROGRAMMING BEAM HEADINGS INTO MEMORY

1. Press the [KEY4(MODE)] key, as necessary, to select the "PRESET" or "MANUAL" mode.
2. Use the techniques learned previously to rotate the antenna to the desired beam heading.
3. Now press the [KEY4(MODE)] key to select the "MEMORY" mode.
4. Select the desired memory channel register by using the [KEY2(▼)] key and [KEY3(▲)] keys, then press the [KEY6(MW)] key to memorize the programmed beam heading.

Advice: The maximum number of beam-heading memories which can be stored is 9.

If you have connected your after-market keyboard to the **DMU-2000**, you can append a name (tag) to the memory channel (maximum: 6 characters). It is often convenient to enter the callsign of a station, or perhaps a label such as "Europe" for easy reference. The method of entering the name tag into a memory is described below.

1. Use the [KEY2(▼)] key and [KEY3(▲)] keys to select the rotator memory register onto which you wish to append a name tag.
2. Press the keyboard's [ENTER] key; the cursor on the screen will blink.
3. Use your keyboard to enter the name tag; a maximum of six characters may be utilized.

MEMORY RECALL

1. Use the [KEY2(▼)] key and [KEY3(▲)] keys to select the desired location from the rotator memory list.
2. When you briefly press the [KEY5(MR/ERASE)] key, the rotator will turn to the memorized beam heading.

ERASING MEMORY

1. Use the [KEY2(▼)] key and [KEY3(▲)] keys to select the rotator memory you wish to erase.
2. Press the [KEY5(MR/ERASE)] key for 2 seconds to erase the memory's data.

Note: Once erased, memory data cannot be restored!



"REGULAR COMPASS" DISPLAY



"GREAT CIRCLE MAP" DISPLAY

MANUAL REFERENCE	FT-950 FTDX5000	FT-2000 FT-2000D
[KEY1(XXX)]	[1.8(1)]	[F1(CH-1)]
[KEY2(XXX)]	[3.5(2)]	[F2(CH-2)]
[KEY3(XXX)]	[7(3)]	[F3(CH-3)]
[KEY4(XXX)]	[10(4)]	[F4(CH-4)]
[KEY5(XXX)]	[14(5)]	[F5(MEM)]
[KEY6(XXX)]	[18(6)]	[F6(DEC)]
[KEY7(XXX)]	[21(7)]	[F7(P.BACK)]
[KEY8(XXX)]	[24.5(8)]	[DISPLAY]

USING THE MEMORY CHANNEL LIST

ABOUT THE MEMORY CHANNEL LIST

This is the screen which displays the transceiver's memory channels. On the list, the channel number, ID tag, frequency, and operating mode are shown. The transceiver has an extensive memory system of 99 channels that may be arrayed into up to six groups, and you can check the entire memory system's status by viewing this screen.

If the "Memory Channel List" screen does not initially appear, press the [KEY8(DISPLAY)] key to switch the Function key's function to "Page Select Key," then press the [KEY7(MCH LIST)] key momentarily to display the "Memory Channel List" screen. Next, press the [KEY8(DISPLAY)] key again to switch the Function key's function to the "Function Key."

EXPLANATION OF THE FUNCTION KEYS ON THE MEMORY CHANNEL LIST SCREEN

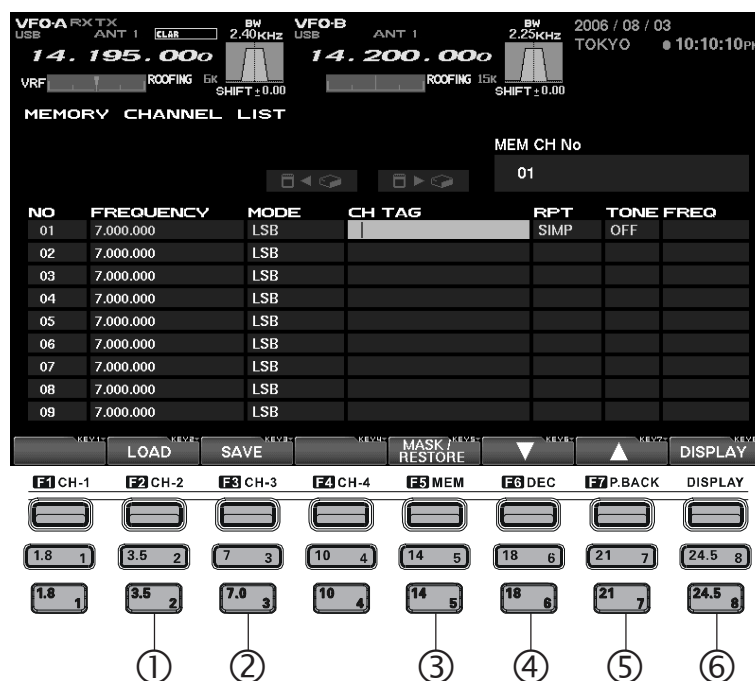

① [KEY2(LOAD)] Key

Press this key to load memory data previously saved on the CF card to the **DMU-2000**.

② [KEY3(SAVE)] Key

Press this key to save the current memory data to the CF card.

③ [KEY5(MASK/RESTORE)] Key

It is possible to erase the currently selected memory channel data by pressing this key. If you want to restore the erased memory data, press this key again after erasing the memory.

④ [KEY6(▼)] Key

Use this key to move the highlighted field on the memory list downward.

⑤ [KEY7(▲)] Key

Use this key to move the highlighted field on the memory list upward.

⑥ [KEY8(DISPLAY)] Key

Press this key briefly to switch the Function key operations between the "Page Select Keys" and the "Function Keys."

Press and hold in this key to disable **DMU-2000** control, and return the key buttons to control of the **FT-2000/D**, **FT-950**, or **FTDx5000** operations.

USING THE MEMORY CHANNEL LIST

ERASING A MEMORY CHANNEL/RESTORING AN ERASED MEMORY CHANNEL

You can erase data from any memory channel which is no longer needed. It also is possible to restore (immediately after deletion) erased memory channel data, in case you erase something by accident.

1. Select the memory channel you want to erase by pressing the [KEY6(▼)] key or [KEY7(▲)] key.
2. To mask the current memory's contents, press the [KEY5(MASK/RESTORE)] key. If you want to restore the erased memory channel's data, press the [KEY5(MASK/RESTORE)] key once more.

MANUAL REFERENCE	FT-950 FT-DX5000	FT-2000 FT-2000D
[KEY1(XXX)]	[1.8(1)]	[F1(CH-1)]
[KEY2(XXX)]	[3.5(2)]	[F2(CH-2)]
[KEY3(XXX)]	[7(3)]	[F3(CH-3)]
[KEY4(XXX)]	[10(4)]	[F4(CH-4)]
[KEY5(XXX)]	[14(5)]	[F5(MEM)]
[KEY6(XXX)]	[18(6)]	[F6(DEC)]
[KEY7(XXX)]	[21(7)]	[F7(P.BACK)]
[KEY8(XXX)]	[24.5(8)]	[DISPLAY]



[KEY5(MASK/RESTORE)] Key

Advice: A memory channel which has been erased can be restored by pressing the [KEY5(MASK/RESTORE)] key again, but if any other key has been pressed after you erased the memory channel, the memory cannot be restored.

SAVING MEMORY DATA

Memory data from the transceiver's internal memory may be saved to the supplied Compact Flash (CF) card.

1. Press the [KEY3(SAVE)] key to open the Save window.

If there are several file names stored, select the desired file by pressing the [KEY6(▼)] key and [KEY7(▲)] keys.



2. If you want to over-write the file name, go to step 3. If you do not want to over-write the data on an existing file name, and want to save the data in the new file: press the [KEY4(FILE)] key; now enter the desired file name from your keyboard (the file extension will be ".mcl" for Menu data).

3. Press the [KEY3(GO)] key to save the data into the CF card.

If you want to cancel the saving of the memory data, press the [KEY2(CANCEL)] key.

Advice: When the ERROR message "CF CARD IS NOT READY" appears on the display, please confirm that the CF card is inserted correctly into its slot.

When memory data is saved to the CF card under a previously-used file name, the previous file will be overwritten, and the old data will be erased.



[KEY3(SAVE)] Key



[KEY3(GO)] Key

USING THE MEMORY CHANNEL LIST

LOADING MEMORY DATA

Loading Memory Data from the CF Card to the transceiver's memory.

1. Press the **[KEY2(LOAD)]** key to open the memory loading window.

If there are multiple file names stored on the CF card, select the desired file using the **[KEY6(▼)]** key or the **[KEY7(▲)]** key.



2. Press the **[KEY3(GO)]** key to commence loading of the memory data to the **DMU-2000**. If you wish to cancel the download, press the **[KEY2(CANCEL)]** key.

MANUAL REFERENCE	FT-950 FTdx5000	FT-2000 FT-2000D
[KEY1(XXX)]	[1.8(1)]	[F1(CH-1)]
[KEY2(XXX)]	[3.5(2)]	[F2(CH-2)]
[KEY3(XXX)]	[7(3)]	[F3(CH-3)]
[KEY4(XXX)]	[10(4)]	[F4(CH-4)]
[KEY5(XXX)]	[14(5)]	[F5(MEM)]
[KEY6(XXX)]	[18(6)]	[F6(DEC)]
[KEY7(XXX)]	[21(7)]	[F7(P.BACK)]
[KEY8(XXX)]	[24.5(8)]	[DISPLAY]

Advice: When the ERROR message “CF CARD IS NOT READY” appears on the display, please confirm that the CF card is inserted correctly into its slot.

When the memory data is loaded from the CF card to the **DMU-2000** memory, all previous data will be over-written and the old data will be erased. Please remember to save the current memory contents to the CF card, if you want to retrieve it later.



[KEY2(LOAD)] Key



[KEY3(GO)] Key

USING THE MENU MODE

The **DMU-2000** can display the Menu Mode List of the transceiver on the display. Press and hold in the **FT-2000's** [DISPLAY] key (or the [ENT] key of the **FT-950** or **FTdx5000**) for more than two seconds, white letters will appear in the tabs at the bottom of the screen to indicate various functions. Then, press the [MENU] button briefly to bring up the Menu Mode Screen. Press the [MENU] button again to close the Menu Mode Screen.

EXPLANATION OF THE FUNCTION KEYS ON THE MENU MODE SCREEN



① [KEY2(Load)] Key

Press this key to download previously-used Menu settings from the CF card to the transceiver.

② [KEY3(Save)] Key

Press this key to save the current Menu settings to the CF card.

③ [KEY4(Left Arrow)] Key

Use this key to select the configuration value of the menu item. The value may also be changed by rotating the **FT-2000/D's** [SUB VFO-B] knob (or **FT-950's** [CLAR/VFO-B] knob or **FTdx5000's** (VFO-B)[SELECT] knob).

④ [KEY5(Right Arrow)] Key

Use this key to select the configuration value of the menu item. The value may also be changed by rotating the **FT-2000/D's** [SUB VFO-B] knob (or **FT-950's** [CLAR/VFO-B] knob or **FTdx5000's** (VFO-B)[SELECT] knob).

⑤ [KEY6(Down Arrow)] Key

This is the “down” key for scrolling through the menu mode list. The items also can be selected by rotating the Main Tuning Dial knob of the **FT-2000/D** and **FT-950**, or the (VFO-B)[SELECT] knob of the **FTdx5000**.

⑥ [KEY7(Up Arrow)] Key

This is the “up” key for scrolling through the menu mode list. The items also can be selected by rotating the Main Tuning Dial knob of the **FT-2000/D** and **FT-950**, or the (VFO-B)[SELECT] knob of the **FTdx5000**.

When you have completed making all changes to the menu setting(s), *press the [MENU] button for 2 seconds to lock in the changes*. If you do not want to keep the changes, press the [MENU] button only briefly; the radio will return to the previous menu status that was in use before you made the changes.

USING THE MENU MODE

MENU MODE CONFIGURATION CHANGES

When you want to change a menu mode setting, follow the procedure described below.

1. Press the **[MENU]** button briefly.

The monitor will display the Menu page. Included on this page will be the Menu Group, Menu Item Name, Menu Item Number, and the current status (setting) for each Menu item.

2. Use the **[KEY6(▼)]/[KEY7(▲)]** keys or Main Tuning Dial (for **FT-2000/D** and **FT-950**, or **(VFO-B)[SELECT]** knob for **FTdx5000**), to select the Menu item you wish to work on.

3. Use the **[KEY4(◀)]/[KEY5(▶)]** keys or **[SUB VFO-B]** knob (for **FT-2000/D**, **[CLAR/VFO-B]** knob for **FT-950**, or **(VFO-B)[SELECT]** knob for **FTdx5000**), to change the setting of the selected Menu item.

4. Press and hold the **[MENU]** button for 2 seconds to save (within the transceiver) the new setting; the menu screen will close, and you will then return to the screen that was in use before entering the menu mode.

If you press the **[MENU]** button briefly to exit, the new settings will not be saved, and you will exit from the menu mode without retaining the new configuration.



"MENU" PAGE

MANUAL REFERENCE	FT-950 FTdx5000	FT-2000 FT-2000D
[KEY1(XXX)]	[1.8(1)]	[F1(CH-1)]
[KEY2(XXX)]	[3.5(2)]	[F2(CH-2)]
[KEY3(XXX)]	[7(3)]	[F3(CH-3)]
[KEY4(XXX)]	[10(4)]	[F4(CH-4)]
[KEY5(XXX)]	[14(5)]	[F5(MEM)]
[KEY6(XXX)]	[18(6)]	[F6(DEC)]
[KEY7(XXX)]	[21(7)]	[F7(P.BACK)]
[KEY8(XXX)]	[24.5(8)]	[DISPLAY]

MENU MODE RESET

It is possible to reset (only) the Menu mode settings back to their factory default. Do this if you want to clear all settings out, and start fresh with the original values.

1. Turn the front panel **[POWER]** switch off.
2. Press and hold in the **[MENU]** button, and while holding it in, press the **[POWER]** switch to turn the transceiver back on. Now, release the **[MENU]** button.

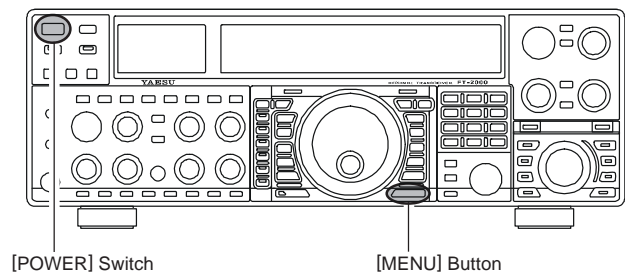

FT-2000/D

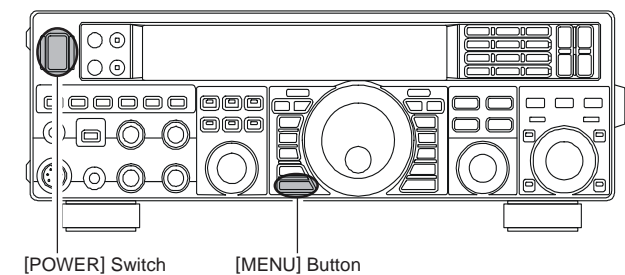

FT-950

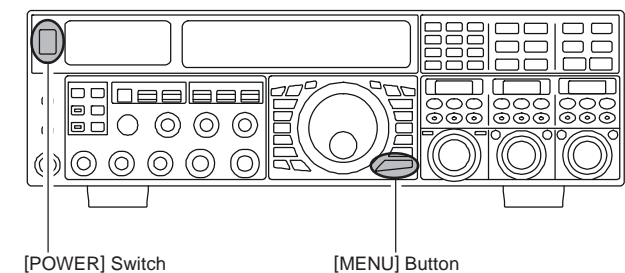

FTdx5000

USING THE MENU MODE

SAVING MENU CONFIGURATION DATA

You may save the current Menu configuration data to the CF card, for archive purposes or for quickly changing extensive transceiver settings for different operating applications.

1. Press the [KEY3(SAVE)] key to open the Save window. If there are multiple file names already stored, select the desired file by pressing the [KEY6(▼)] and [KEY7(▲)] keys.



2. If you want to over-write the file name, go to step 3. If you do not want to over-write the data on an existing file name, and want to save the data in a new file: press the [KEY4(FILE)] key; now enter the desired file name from your keyboard (the file extension will be “.mep” for Menu data).
3. Press the [KEY3(GO)] key to save the data onto the CF card. If you wish to cancel the saving of the data, press the [KEY2(CANCEL)] key.

Advice: When the ERROR message “CF CARD IS NOT READY” appears on the display, please confirm that the CF card is inserted correctly into its slot.

When the memory data is saved to the CF card under a previously-used file name, the old/previous data will be over-written and the old data erased.



[KEY3(SAVE)] Key



[KEY3(GO)] Key

LOADING MENU DATA

Loading Menu Data from the CF Card

1. Press the [KEY2(LOAD)] key to open the “Load” window. If there are several file names stored, select the desired file by pressing the [KEY6(▼)] and [KEY7(▲)] keys.



2. Press the [KEY3(GO)] key to download the Menu configuration from the CF card to the radio. To cancel the download, press the [KEY2(CANCEL)] key.

Advice: When the ERROR message “CF CARD IS NOT READY” appears on the display, please confirm that the CF card is inserted correctly into the card reader slot.

When the Menu data is loaded from the CF card to the Menu on the transceiver, the old/previous menu data will be over-written, and the old data erased.



[KEY2(LOAD)] Key



[KEY3(GO)] Key

MANUAL REFERENCE	FT-950 FTdx5000	FT-2000 FT-2000D
[KEY1(XXX)]	[1.8(1)]	[F1(CH-1)]
[KEY2(XXX)]	[3.5(2)]	[F2(CH-2)]
[KEY3(XXX)]	[7(3)]	[F3(CH-3)]
[KEY4(XXX)]	[10(4)]	[F4(CH-4)]
[KEY5(XXX)]	[14(5)]	[F5(MEM)]
[KEY6(XXX)]	[18(6)]	[F6(DEC)]
[KEY7(XXX)]	[21(7)]	[F7(P.BACK)]
[KEY8(XXX)]	[24.5(8)]	[DISPLAY]



Copyright 2010
VERTEX STANDARD CO., LTD.
All rights reserved

No portion of this manual
may be reproduced without
the permission of
VERTEX STANDARD CO., LTD.

Printed in Japan

